

# Operating Instruction

## SS500/SS2000 TDLAS Gas Analyzer

CSA Class I, Division 2, Groups A, B, C & D; T3C

Class I, Zone 2 IIC T3C



### Product/Firmware Matrix

PRODUCT MODEL	HC12 Firmware	FS Firmware	NS Firmware
SS2100, SS2100a, SS2100i-1, SS2100i-2	Not used	Used for differential analyzers	Used for non- differential analyzers
2-Pack/3-Pack	Used on right- side analyzer electronics	Used on left- side analyzer electronics	Not used
SS1000, SS500, SS500e, SS500XP, SS2000, SS2000e, SS2000XP, SS3000, SS3000e	Used	Not used	Not used

Copyright © 2021 Endress+Hauser, Inc. No part of this manual may be reproduced in whole or in part without the express written permission of Endress+Hauser, Inc. Endress+Hauser reserves the right to change product design and specifications at any time without prior notice.

# TABLE OF CONTENTS

---

## 1: Introduction

Who Should Read This Manual . . . . .	1-1
How to Use This Manual. . . . .	1-1
Conventions used in this manual . . . . .	1-1
General Warnings and Cautions . . . . .	1-1
Safety warning label. . . . .	1-2
Equipment labels . . . . .	1-3
Instructional symbols . . . . .	1-3
How the Analyzers Work . . . . .	1-4
Wavelength Modulation Spectroscopy (WMS) Signal Detection . . . . .	1-7
Getting Familiar with the Analyzer . . . . .	1-8
Fuses . . . . .	1-8

## 2: Safety

Potential Risks Affecting Personnel . . . . .	2-1
Mitigating risks . . . . .	2-1
To mitigate electrocution hazard . . . . .	2-1
To mitigate exposure to process gases . . . . .	2-1
Explosion hazard . . . . .	2-2

## 3: Installation

What Should be Included in the Shipping Box . . . . .	3-1
Inspecting the Analyzer . . . . .	3-1
Installing the Analyzer. . . . .	3-2
Hardware and tools for installation. . . . .	3-2
Hardware. . . . .	3-2
Tools . . . . .	3-2
Lifting/carrying the analyzer . . . . .	3-2
Mounting the analyzer . . . . .	3-3
To mount the analyzer . . . . .	3-3
Connecting Electrical Power to the Analyzer . . . . .	3-4
Protective chassis and ground connections . . . . .	3-4
To connect electrical power to the analyzer. . . . .	3-5
Connecting the Output Signals . . . . .	3-7
To connect the output signals . . . . .	3-8
Changing the 4-20 mA Current Loop Mode. . . . .	3-9
To change the 4-20 mA board from source to sink. . . . .	3-9
Calibrating the analog output . . . . .	3-10
Testing and adjusting the 4-20 mA zero and span . . . . .	3-11
Connecting the Gas Lines. . . . .	3-11
To connect the sample supply line . . . . .	3-12
To connect the sample return . . . . .	3-13
Conditioning the SCS Tubing . . . . .	3-14

## 4: Sample Conditioning System (SCS)

About the SCS . . . . .	4-2
Checking the SCS Installation. . . . .	4-4
To perform SCS installation checks . . . . .	4-4
SCS Start-up . . . . .	4-4
To prepare for SCS startup . . . . .	4-4
To start up the field pressure reducing station. . . . .	4-5
Starting up the full-featured sample system . . . . .	4-5

To start up the sample bypass stream on process sample . . . . . 4-6  
 To start up the analyzer on process sample . . . . . 4-6  
 Starting up the Simplified Sample System . . . . . 4-7  
 To start up the simplified sample system . . . . . 4-7  
 Shutting Down the SCS . . . . . 4-9  
     To isolate the analyzer for short-term shutdown (full-featured sample system) . . . . . 4-9  
     To isolate the analyzer for long-term shutdown (full-featured sample system) . . . . . 4-10  
     To isolate the analyzer for shutdown (simplified sample system) . . . . . 4-11

**Appendix A: Specifications**

Spare Parts . . . . . A-13

**Appendix B: Maintaining & Troubleshooting**

Gas Leaks . . . . . B-1  
 Contamination . . . . . B-1  
     To keep the sampling lines clean . . . . . B-1  
 Excessive Sampling Gas Temperatures and Pressures . . . . . B-2  
 Electrical Noise . . . . . B-2  
 Powering Down the Analyzer . . . . . B-2  
     To power down the analyzer . . . . . B-2  
 Peak Tracking Reset Procedure . . . . . B-3  
 Mirror Cleaning/Replacement . . . . . B-3  
     To determine the type of cell mirror . . . . . B-3  
     Tools and supplies . . . . . B-5  
     To clean the glass mirrors . . . . . B-5  
     To replace the stainless steel mirror . . . . . B-7  
 Pressure Sensor Replacement . . . . . B-8  
     Tools and materials . . . . . B-8  
     To replace the pressure sensor . . . . . B-9  
     To unlock/set the flow meter . . . . . B-13  
     Tools . . . . . B-13  
     To replace the membrane separator filter . . . . . B-14  
     To replace the rotameter (SS500 simplified sample system only) . . . . . B-15  
     Tools . . . . . B-16  
 Periodic SCS Maintenance . . . . . B-17  
     To perform regular SCS status check . . . . . B-18  
     To check filters . . . . . B-18  
 Instrument Problems . . . . . B-19  
 Service . . . . . B-22  
     Before contacting Service . . . . . B-22  
     Service repair order . . . . . B-22  
     Renewity returns . . . . . B-23  
 Packing . . . . . B-23  
     To purge the analyzer for shipment or relocation . . . . . B-23  
     To prepare the analyzer for shipment or storage . . . . . B-23  
 Storage . . . . . B-24  
 Disclaimers . . . . . B-24  
 Warranty . . . . . B-24  
**Index** . . . . . Index-1

# 1 - INTRODUCTION

---

Endress+Hauser's SS500/SS2000 products are high-speed, diode laser-based extractive analyzers designed for extremely reliable monitoring of moisture and carbon dioxide in natural gas applications. To ensure that the analyzer performs as specified, it is important to closely review the installation and operation sections of this manual. This manual contains a comprehensive overview of the SS500/SS2000 analyzer and step-by-step instructions on:

- Getting familiar with the analyzer
- Installing the analyzer and sample conditioning system (SCS)
- Maintaining and troubleshooting the system

For instruction on operating the analyzer through firmware programming, please consult the Description of Device Parameters.

## Who Should Read This Manual

This manual should be read and referenced by anyone installing, operating or having direct contact with the analyzer.

## How to Use This Manual

Take a moment to familiarize yourself with this manual by reading the **Table of Contents**.

There are a number of options and accessories available for the SS500/SS2000 analyzers. This manual has been written to address the most common options and accessories. Images, tables and charts are included to provide a better understanding of the analyzer and its functions. Special symbols are also used to provide the user with key information regarding the system configuration and/or operation. Pay close attention to this information.

## Conventions used in this manual

In addition to the symbols and instructional information, use "hot links" to quickly navigate between different sections. These links include table, figure and section references and are identified by a pointing finger cursor  when rolling over the text. Click on the link to navigate to the reference.

## General Warnings and Cautions

Instructional icons are provided in this manual to alert the user of potential hazards, important information and valuable tips. Following are the symbols and associated warning and caution types to observe when servicing the analyzer. Some of these symbols are provided for instructional purposes only and are not labeled on the system.

## Safety warning label

The warning label shown below will be affixed to the front side of all analyzer enclosures that contain sample gas.



Hazards may vary by stream composition. One or more of the following conditions may apply.



**Flammable.** Gases used in the processing of this analyzer may be extremely flammable. Any work in a hazardous area must be carefully controlled to avoid creating any possible ignition sources (e.g., heat, arcing, sparking, etc.).



**Toxins.** Endress+Hauser analyzers measure a variety of gases, including high-level  $H_2S$ . Follow all safety protocols governing toxic gases and potential leaks.



**Inhalation.** Inhaling toxic gases or fumes may cause physical damage or death.



Technicians are expected to follow all safety protocols established by the customer that are necessary for servicing or operating the analyzer. This may include, but is not limited to, lockout/tag-out procedures, toxic gas monitoring protocols, personal protective equipment (PPE) requirements, hot work permits and other precautions that address safety concerns related to performing service or operation on process equipment located in hazardous areas.

## Equipment labels



Warning statement for **hazardous voltage**. Contact may cause electric shock or burn. Turn off and lock out system before servicing.



Failure to follow all directions may result in damage or malfunction of the analyzer.



Maximum voltage and current specifications for the fuse closest to label.



**PROTECTIVE EARTH GROUND** — Symbol indicates the connection point of the ground wire from the main power source.

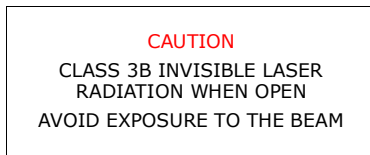

**INVISIBLE LASER RADIATION** — Avoid exposure to beam. Class 3b Radiation Product. Refer servicing to the manufacturer or qualified personnel.



Removing label from measurement cell optical head will void analyzer warranty.

## Instructional symbols



General notes and important information concerning the installation and operation of the analyzer.



*Failure to follow all directions may result in fire.*



**INVISIBLE LASER RADIATION** — *Avoid exposure to beam. Class 3b Radiation Product. Refer servicing to the manufacturer-qualified personnel.*



*Failure to follow all directions may result in damage or malfunction of the analyzer.*



*Maximum voltage and current specifications for fuses.*

## How the Analyzers Work

The SS500/SS2000 analyzers employ SpectraSensors' tunable diode laser absorption spectroscopy (TDLAS) to measure the concentration of contaminants such as moisture in a background of natural gas. Absorption spectroscopy is a widely used technique for sensitive trace species detection. Because the measurement is made in the volume of the gas, the response is much faster, more accurate and significantly more reliable than traditional surface-based sensors that are subject to surface contamination.

In its simplest form, a diode laser absorption spectrometer consists of a sample cell with a mirror at one end, and a mirror or window at the opposite end, through which the laser beam can pass. Refer to Figure 1-1. The laser beam enters the cell and reflects off the mirror(s) making one or more trips through the sample gas and eventually exiting the cell where the remaining beam intensity is measured by a detector. Sample gas flows continuously through the sample cell ensuring rapid and continuous measurements.



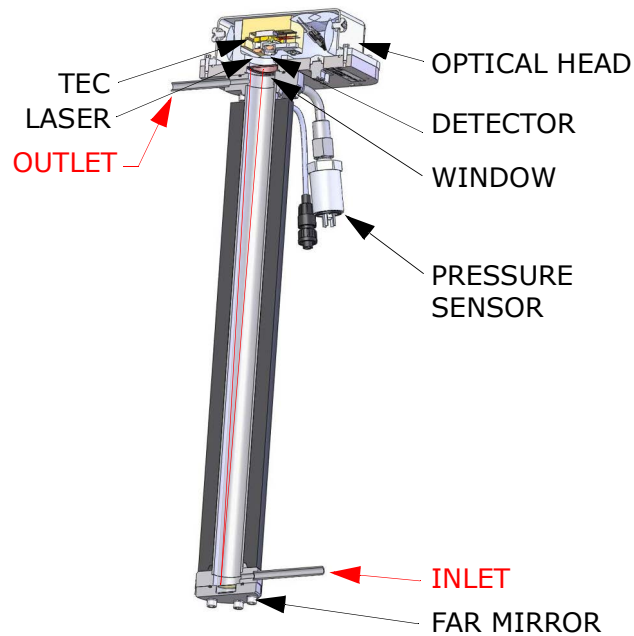

### 0.8 m Measurement Cell

**Figure 1-1** Schematic of typical tunable diode laser absorption spectrometer

Due to their inherent structure, the molecules in the sample gas each have characteristic natural frequencies (or resonances). When the output of the laser is tuned to one of those natural frequencies, the molecules with that particular resonance will absorb energy from the incident beam. That is, as the beam of incident intensity,  $I_0(\lambda)$ , passes through the sample, attenuation occurs via absorption by the measured gas with absorption cross section  $\sigma(\lambda)$ . According to the Beer-Lambert absorption law, the intensity remaining,  $I(\lambda)$ , as measured by the detector at the end of the beam path of length  $[l]$  (cell length x number of passes), is given by

$$I(\lambda) = I_0(\lambda)e^{-\sigma(\lambda) \cdot n \cdot l} \quad (1)$$

where  $n$  represents the gas density. Thus, the ratio of the absorption measured when the laser is tuned on-resonance versus off-resonance is directly proportional to the number of molecules of that particular species in the beam path, or

$$n = \frac{-1}{\sigma(\lambda) \cdot l} \ln \left[ \frac{I(\lambda)}{I_0(\lambda)} \right] \quad (2)$$

Figure 1-2 shows the typical raw data from a TDL absorption spectrometer scan including the incident laser intensity,  $I_0(\lambda)$ , and the transmitted intensity,  $I(\lambda)$ , for a clean system and one with contaminated mirrors (shown to illustrate the system's relative insensitivity to mirror contamination). The positive slope

of raw data results from ramping the current to tune the laser, which not only increases the wavelength with current, but also causes the corresponding output power to increase. By normalizing the signal by the incident intensity, any laser output fluctuations are canceled, and a typical, yet more pronounced, absorption profile results. Refer to Figure 1-3.

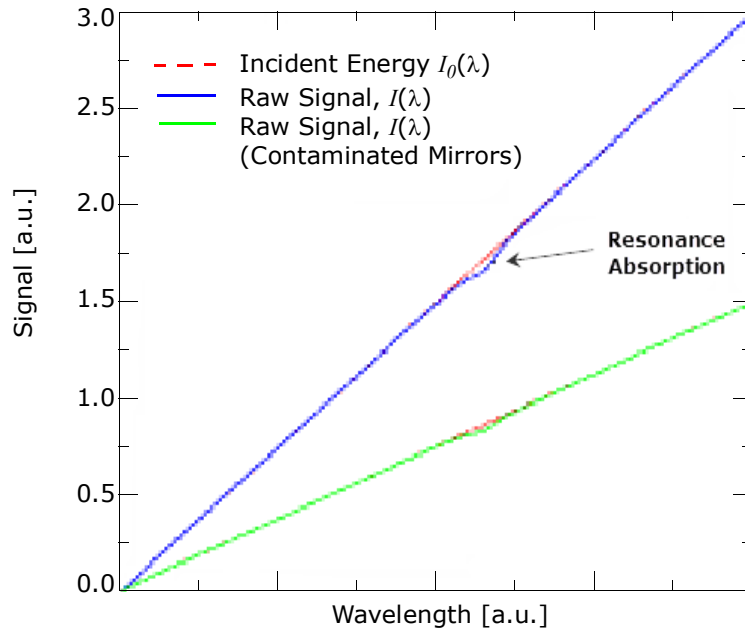

**Figure 1-2** Typical raw signal from a tunable diode laser absorption spectrometer with and without mirror contamination

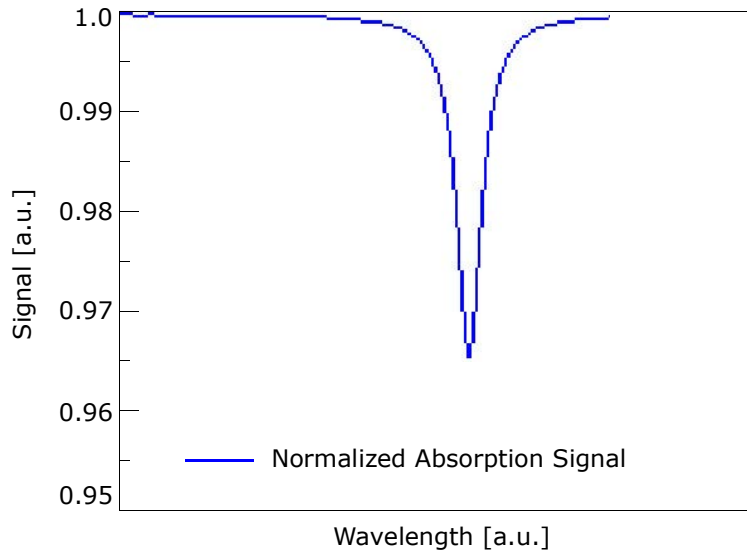
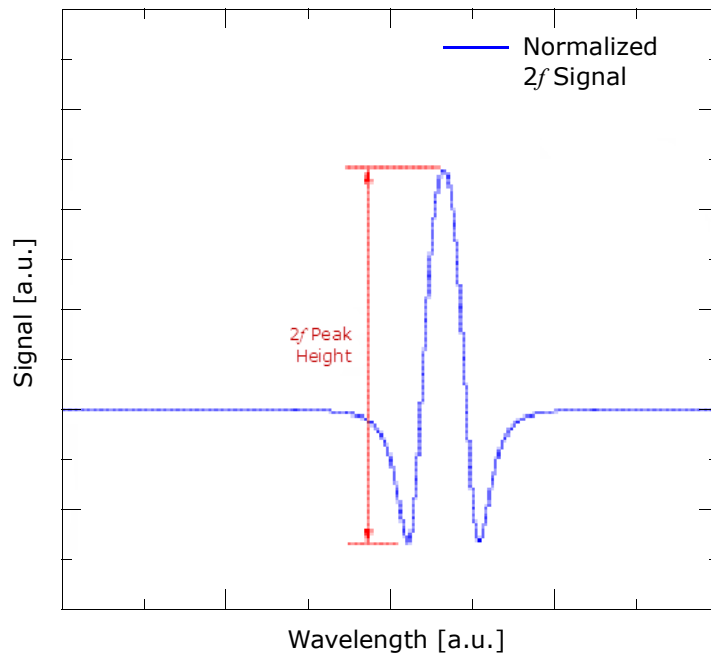

**Figure 1-3** Typical normalized absorption signal from a tunable diode laser absorption spectrometer

Note that contamination of the mirrors results solely in lower overall signal. However, by tuning the laser off-resonance as well as on-resonance and normalizing the data, the technique self calibrates every scan resulting in measurements that are unaffected by mirror contamination.

## Wavelength Modulation Spectroscopy (WMS) Signal Detection

Endress+Hauser takes the fundamental absorption spectroscopy concept a step further by using a sophisticated signal detection technique called wavelength modulation spectroscopy (WMS). When employing WMS, the laser drive current is modulated with a kHz sine wave as the laser is rapidly tuned. A lock-in amplifier is then used to detect the harmonic component of the signal that is at twice the modulation frequency ( $2f$ ), as shown in Figure 1–4. This phase-sensitive detection enables the filtering of low-frequency noise caused by temperature and/or pressure fluctuations, low-frequency noise in the laser beam or thermal noise in the detector.



**Figure 1–4** Typical normalized  $2f$  signal; species concentration is proportional to the peak height

With the resulting low-noise signal and use of fast post-processing algorithms, reliable parts per million (ppm) or parts per billion (ppb) detection levels are possible (depending on target and background species) at real-time response rates (on the order of 1 second).

All Endress+Hauser TDLAS gas analyzers employ the same design and hardware platform. Measuring different trace gases in various mixed hydrocarbon background streams is accomplished by selecting a laser wavelength that provides the least amount of sensitivity to background stream variations.

## Getting Familiar with the Analyzer

The SS500 and SS2000 are single-channel analyzers designed to continuously measure the moisture content in natural gas pipelines. The SS2000 offers higher measurement performance in those applications, and its single measurement channel can also be configured to monitor CO<sub>2</sub> levels in natural gas pipelines, or to measure the moisture content in CO<sub>2</sub> pipelines. For performance specifications, refer to Table A-1 and Table A-2.

Endress+Hauser's SS500/SS2000 analyzers are typically comprised of a single electronics enclosure and associated measurement cell(s). Refer to Appendix A for the system drawings. On the front panel of the analyzer, the keypad and LCD display serve as the user interface to each analyzer. The analyzer control electronics drive the laser, collect the signal, analyze the spectra and provide measurement output signals. Refer to Figure 1-5.



**Figure 1-5** Analyzer Overview (SS500/SS2000 pictured)

Power is connected to the analyzer from an external power source through the bottom of the enclosure. The measurement cell along with flow devices to control flow and pressure for the measurement cell and the bypass loop may be mounted on a panel alongside the electronics enclosure.

### Fuses

Inside the SS500/SS2000 analyzer electronics enclosure is the electronics assembly. Fuses are located on the electronics control board, as shown in Figure 1-6 and Figure 1-7.



If you need to replace a fuse, use only the same type and rating of fuse as the original as listed in Table 1-1.

**Table 1-1** Fuse specifications

DWG Ref.		Voltage	Description	Rating
Figure 1-6	F1	120 VAC	Miniature Fuse, 5 x 20 mm, Time Delay	250VAC/0.8A
		240 VAC	Miniature Fuse, 5 x 20 mm, Time Delay	250VAC/0.5A
Figure 1-7	F2	12 VDC	Miniature Fuse, 5 x 20 mm, Time Delay	250VAC/3.15A
		24 VDC	Miniature Fuse, 5 x 20 mm, Time Delay	250VAC/1.6A



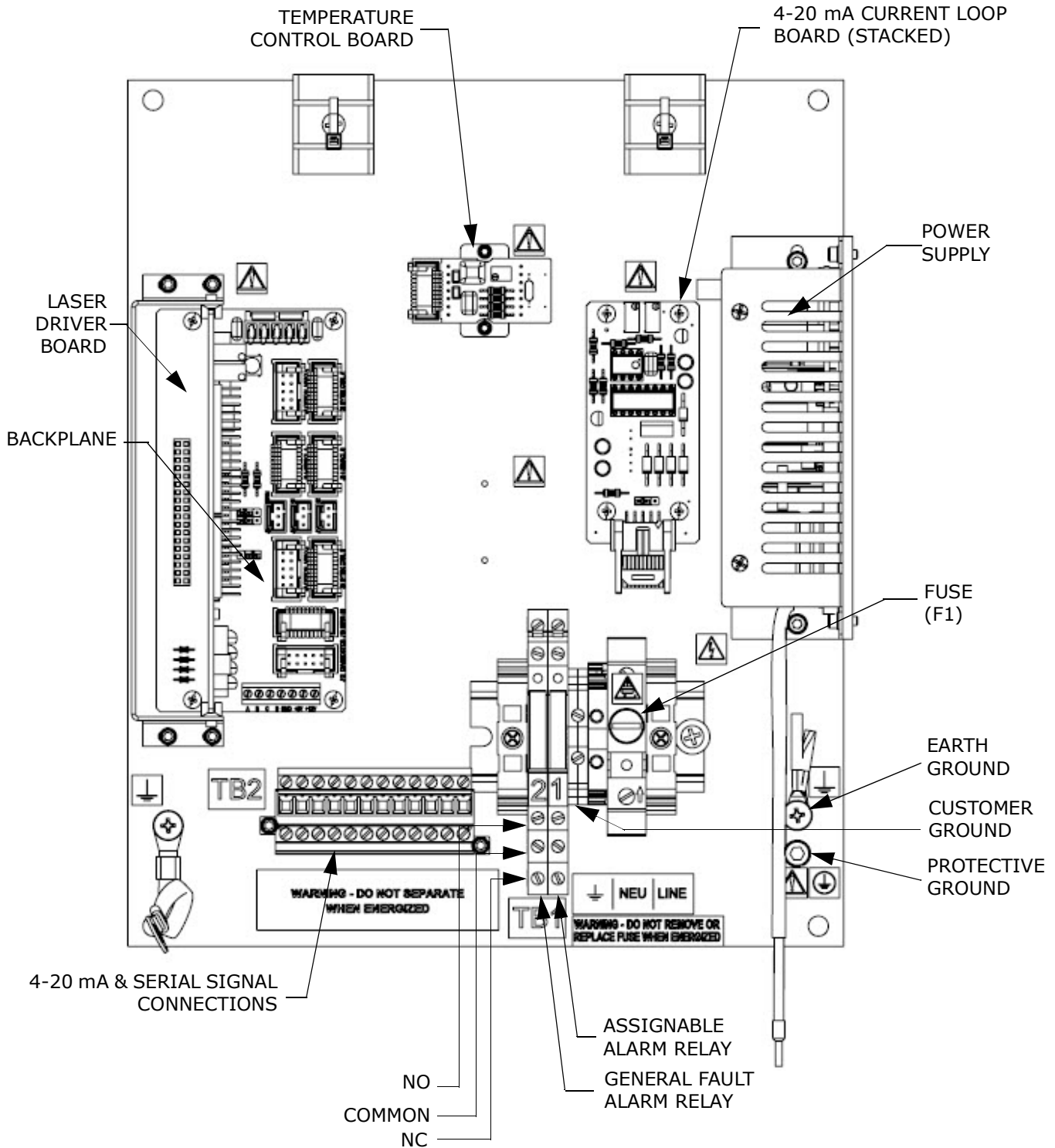

**Figure 1-6** Electronics control board (AC) for single-channel systems (SS500/SS2000)

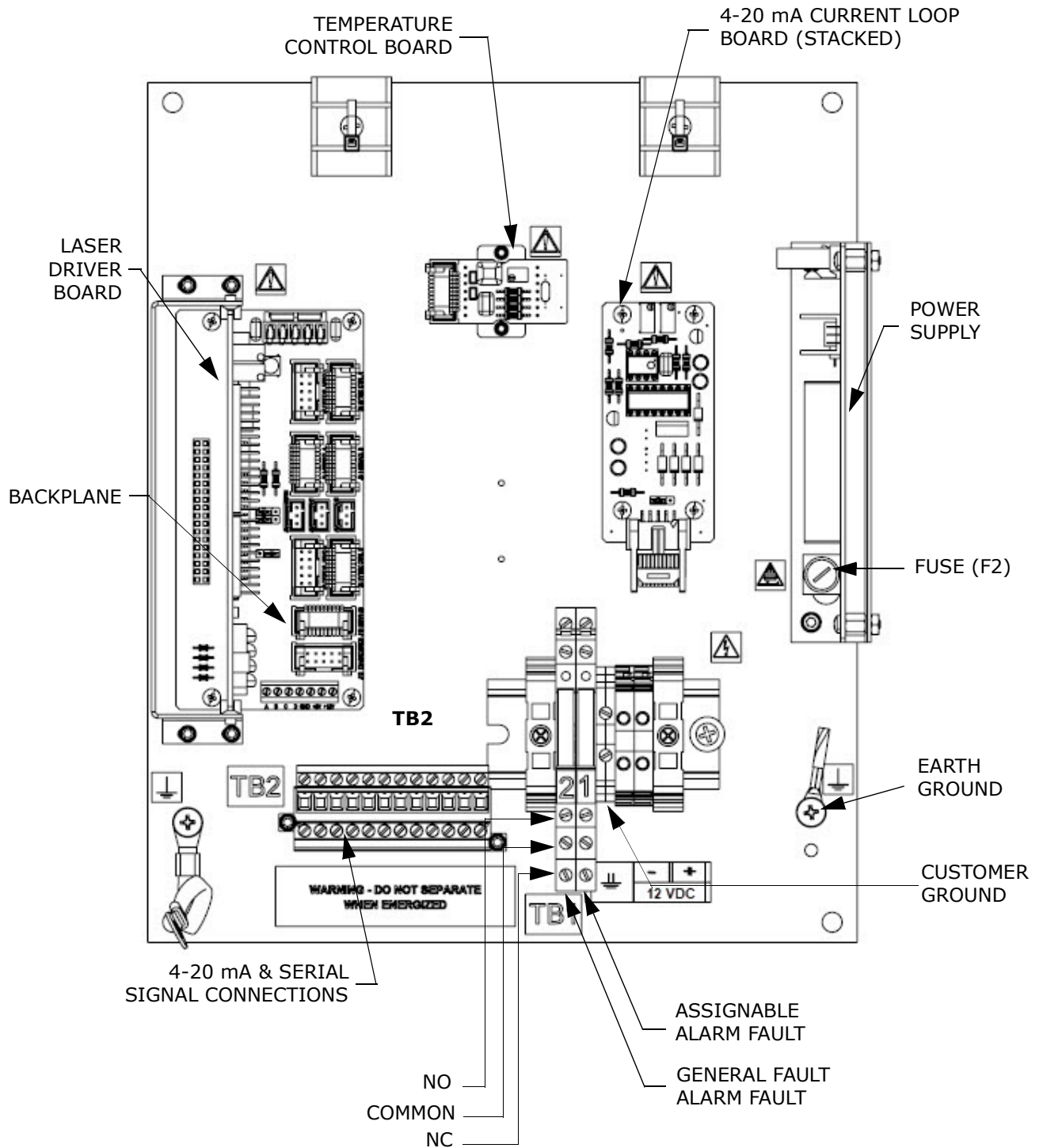

**Figure 1-7** Electronics control board (DC) for single-channel systems (SS500/SS2000)

THIS PAGE INTENTIONALLY LEFT BLANK



## 2 - SAFETY

---

### Potential Risks Affecting Personnel

This section addresses the appropriate actions to undertake when faced with hazardous situations during or before service of the analyzer. It is not possible to list all potential hazards within this document. The user is responsible for identifying and mitigating any potential hazards present when servicing the analyzer.



*Technicians are expected to follow all safety protocols established by the customer that are necessary for servicing the analyzer. This may include, but is not limited to, lockout/tagout procedures, toxic gas monitoring protocols, personal protective equipment (PPE) requirements, hot work permits and other precautions that address safety concerns related to performing service on process equipment located in hazardous areas.*

### Mitigating risks

Refer to the instructions for each situation listed below to mitigate associated risks.

---

#### **To mitigate electrocution hazard**

1. Shut off power at the main disconnect external to the analyzer.



*Complete this action before performing any service that requires working near the main input power or disconnecting any wiring or other electrical components.*

2. Open enclosure door.

If service must be performed with power engaged (gain adjustment, etc.):

1. Note any live electrical components and avoid any contact with them.
2. Only use tools with a safety rating for protection against accidental contact with voltage up to 1000 V (IEC 900, ASTF-F1505-04, VDE 0682/201).

---

#### **To mitigate exposure to process gases**

1. Shut off the process gas to the analyzer before any service that would require opening a part of the sample plumbing.
2. Purge the system with nitrogen.

3. Shut off the nitrogen purge before opening any part of the sample system.

### **Explosion hazard**

Any work in a hazardous area must be carefully controlled to avoid creating any possible ignition sources (e.g., heat, arcing, sparking, etc.). All tools must be appropriate for the area and hazards present. Electrical connections must not be made or broken with power on (to avoid arcing).

# 3 - INSTALLATION

---

This section describes the processes used to initially install and configure your SS500 or SS2000 and optional sample conditioning system (SCS). Once the analyzer arrives, you should take a few minutes to examine the contents before installing the unit.



*The safety of the analyzer is the responsibility of the installer and the organization he/she represents.*



*Endress+Hauser Class I Division 2 analyzers use a non-incendive protection method, and as such all portions of the local installation codes apply. The maximum allowed inductance to resistance ratio (L/R ratio) for the field wiring interface must be less than 25  $\mu\text{H}/\Omega$ .*

## What Should be Included in the Shipping Box

The contents of the crate should include:

- The Endress+Hauser SS500 or SS2000
- Documentation media, which includes this manual and other system manuals
- One external RS-232 serial cable(s) to connect the analyzer to a computer
- Additional accessories or options as ordered

If any of these contents are missing, please refer to **"Service"** on page B-22.

## Inspecting the Analyzer

Unpack and place the unit on a flat surface. Carefully inspect all enclosures for dents, dings, or general damage. Inspect the inlet and outlet connections for damage, such as bent tubing. Report any damage to the carrier.



*Avoid jolting the instrument by dropping it or banging it against a hard surface. Do not attempt to pick up the instrument using the sample cell. Either action may disturb the optical alignment.*

Each analyzer is configured with various accessories and options. If there is any discrepancy in your order, please refer to **"Service"** on page B-22.

## Installing the Analyzer

Installing the analyzer is relatively easy requiring only a few steps that, when carefully followed, will ensure proper mounting and connection. This section includes:

- Hardware and tools for installation
- Mounting the analyzer
- Connecting Electrical Power to the Analyzer
- Connecting the Output Signals
- Connecting the Gas Lines

### Hardware and tools for installation

Depending on the particular model, the configuration of accessories and options ordered, you may need the following hardware and tools to complete the installation and connection processes.

#### Hardware

- 3/8 in. Unistrut® (or equivalent) bolts and spring nuts
- 1/4 in.-20 lag bolts or 1/4 in. machine screws and nuts
- Stainless steel tubing (using 1/4 in. O.D. x 0.035 in. wall thickness, seamless electro-polished stainless steel tubing is recommended)
- 1/2 in. conduit hubs
- Conduit
- Conduit seals

#### Tools

- Hand drill and bits
- Tape measure
- Level
- Pencil
- Socket wrench set
- Screw driver, medium blade
- Crescent wrench, adjustable
- Open-end wrench, 9/16 in.

### Lifting/carrying the analyzer

The SS500 or SS2000 can easily be lifted from the packaging and moved to the installation location. Take care not to lift or carry the analyzer by the measurement cells or the cables connected at the top of the analyzer, or

damage may occur. For analyzers configured inside enclosures, lift the unit by the mounting brackets using at least two individuals and distribute the weight among personnel to avoid injury.

## Mounting the analyzer

The SS500 and SS2000 analyzers are manufactured for wall or Unistrut® (or equivalent) metal framing installations. Depending on your application and configuration, the analyzer may come premounted on a SCS panel to be mounted on a wall or Unistrut framing, or without a panel requiring mounting via the standard electronics enclosure tabs. Refer to the layout diagrams in Appendix A for detailed mounting dimensions.



*When mounting the analyzer, be sure to position the instrument so that it is not difficult to operate adjacent devices. Allow 1 meter (3 feet) of room in front of the analyzer.*



*It is critical to mount the analyzer so that the inlet and outlet lines reach the inlet and outlet connections on the chassis while still maintaining flexibility so that the sample lines are not under excessive stress.*



*Bolts or screws used for wall-mounting must be able to support four times the weight of the instrument. Refer to Appendix A for specifications.*

---

## To mount the analyzer

1. Select a suitable location to mount the analyzer. Choose a shaded area or use an optional analyzer hood (or equivalent) to minimize sun exposure.



*Endress+Hauser analyzers are designed for operation within the specified ambient temperature range of -20 °C to 50 °C (-4 °F to 122 °F). Intense sun exposure in some areas may cause the analyzer temperature to exceed the maximum.*

2. Locate the mounting holes on your unit. Refer to drawings in Appendix A.
3. For wall installations, mark the centers of the top mounting holes.
4. Drill the appropriate size holes for the screws you are using.
5. Hold the analyzer in place and fasten with the top screws.
6. Repeat for the bottom mounting holes.

Once all four screws are tightened the analyzer should be very secure and ready for the electrical connections.

## Connecting Electrical Power to the Analyzer

The analyzer is configured for 100 to 240 VAC at 50/60 Hz single-phase input or optionally 9 to 16 VDC or 18 to 32 VDC input. Check the manufacturing data label or the terminal block labels to determine the power input requirements. All work must be performed by personnel qualified in electrical conduit installation. Conduit seals should be used where appropriate in compliance with local regulations.



**Hazardous voltage and risk of electric shock.** Before attaching the wiring to the analyzer, make sure all power to the analyzer is off.



Careful consideration should be taken when grounding. Properly ground the unit by connecting ground leads to the grounding studs provided throughout the system that are labeled with the ground symbol .



Interconnection of the analyzer enclosure and cell enclosure shall be accomplished using wiring methods approved for Class I, Division 2 hazardous locations as per the Canadian Electrical Code (CEC) Appendix J and the National Electric Code (NEC) Article 501. The installer is responsible for complying with all local installation codes.

Depending on the analyzer configuration, the electrical wiring can typically be connected to the analyzer through a conduit hub located at the bottom of the electronics enclosure. Refer to Appendix A for system drawings.

## Protective chassis and ground connections

Before connecting any electrical signal or power, the protective and chassis grounds must be connected. Requirements for the protective and chassis grounds are as follows:

- The protective and chassis grounds must be of equal or greater size than any other current-carrying conductors, including the optional heater located in the sample conditioning system.
- The protective and chassis grounds must remain connected until all other wiring is removed.
- If the protective and chassis ground is insulated, it must use the green/yellow color.

Refer to Figure 1–6 and Figure 1–7 for the protective and ground locations.

Pull the analyzer ground through the opening on the bottom left of the analyzer enclosure to the chassis ground connection. Refer to Figure 3-1.

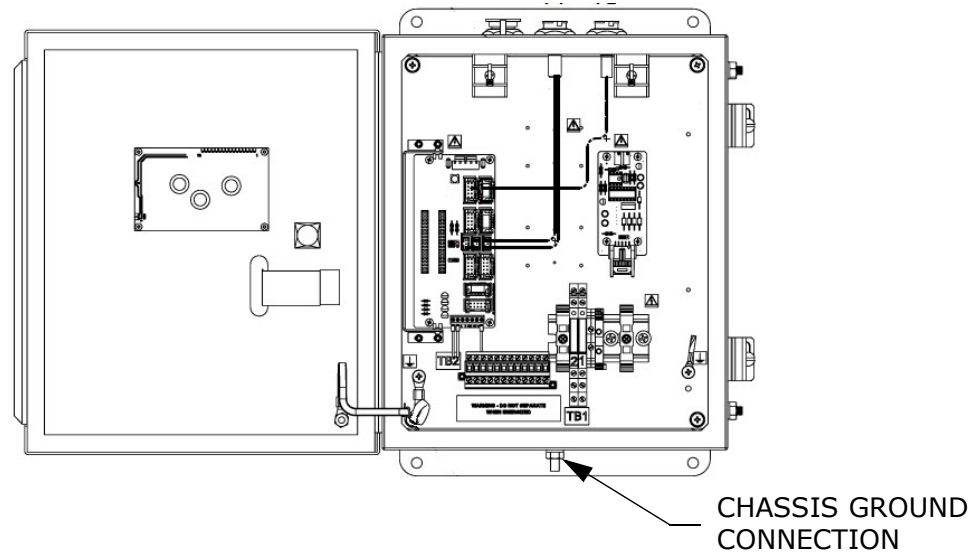

**Figure 3-1** Chassis ground location

## To connect electrical power to the analyzer

1. After the analyzer chassis ground has been connected, open the electronics enclosure door. Take care not to disturb the electrical assembly inside. Refer to Figure 3-2.



**Hazardous voltage and risk of electric shock.** Failure to properly ground the analyzer may create a high-voltage shock hazard.

2. Run conduit from the power distribution panel to the conduit hub on the electronics enclosure labeled for power input.



Conduit seals should be used where appropriate in compliance with local regulations.

3. Connect the ground wire to the protective ground terminal marked  $\oplus$ . Refer to Figure A-10 and Figure A-9.

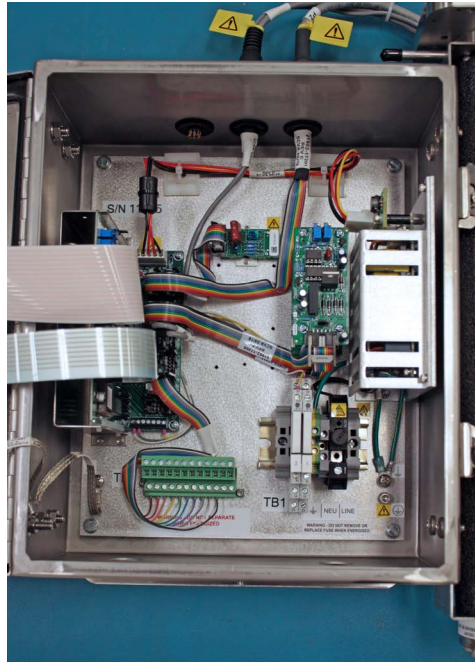

**Figure 3-2** Internal view of electronics enclosure (SS500/SS2000)



*Because the breaker in the power distribution panel or switch will be the primary means of disconnecting the power from the analyzer, the power distribution panel should be located in close proximity to the equipment and within easy reach of the operator, or within 10 feet of the analyzer.*



*An approved switch or circuit breaker rated for 15 amps should be used and clearly marked as the disconnecting device for the analyzer.*

4. For AC systems, route the ground, neutral and hot wires (#14 AWG minimum) into the electronics enclosure.

For DC systems, route the ground, positive and negative wires.

5. Strip the jacket and/or insulation of the wires just enough to connect to the power terminal block.



*If stranded wire is being used, use a crimp wire ferrule to minimize or prevent shorts between terminals.*

6. For AC systems, attach the neutral and hot wires to the power terminal block by connecting the neutral wire to the terminal marked



"NEU" and the hot wire to the terminal marked "LINE" as shown in Figure 3-3.

For DC systems, connect the negative wire to the terminal marked "-" and the positive wire to the terminal marked "+" as shown in Figure 3-3.

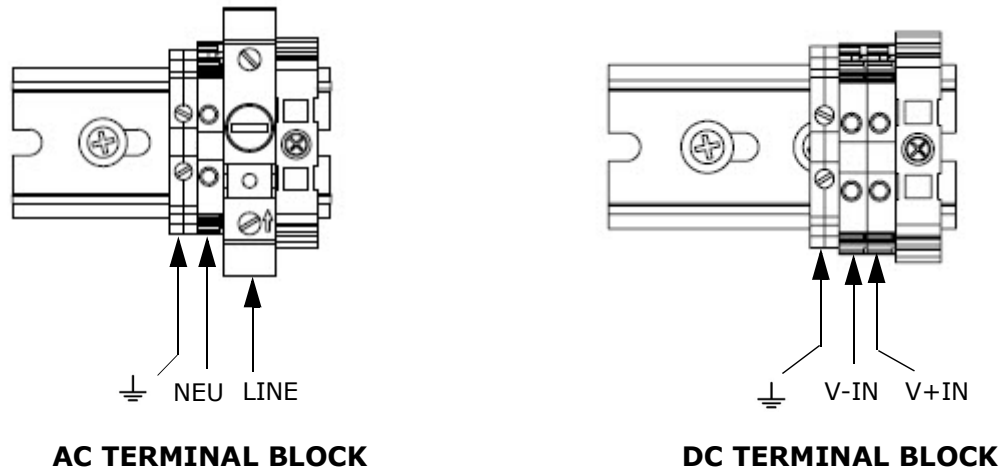

**Figure 3-3** AC and DC connection terminal blocks in electronics enclosure

7. Close and tighten the electronics enclosure door.

## Connecting the Output Signals

The 4-20 mA current loop and serial output(s) are supplied from the mating terminal block (TB2) located inside the analyzer electronics enclosure as shown in Figure 1-6 or Figure 1-7. By default, the 4-20 mA current loop output is factory set to source current.



*The 4-20 mA current loop output is factory set to source current. To change the 4-20 mA current loop output from source to sink, see **"To change the 4-20 mA board from source to sink"** on page 3-9.*

Connections can be made with customer-supplied cables for the current loop(s) and factory-supplied cable for the serial connection(s). Consult the wiring diagrams in Appendix A.



**Hazardous voltage and risk of electric shock.** Be sure power to the analyzer is turned off before opening the electronics enclosure and making any connections.

## To connect the output signals

1. Disconnect power to the analyzer and open the electronics enclosure

*Interconnect cables shall not exceed the following parameters:*



- *The maximum allowed inductance to resistance ratio (L/R ratio) must be less than 25 microhenry/ohm.*
- *The maximum total loop capacitance shall be 0.27 microfarads.*

cover. Take care not to disturb the electrical assembly inside.

2. Run conduit from the signal/alarm receiving station to the conduit hub on the electronics enclosure labeled for signal connections.



*Conduit seals should be used where appropriate in compliance with local regulations.*

3. Route the customer-supplied cable(s) for the current loop(s) and digital output relays through the conduit into the electronics enclosure.
4. Strip back the jacket and insulation of the current loop, digital output relays and serial cables (shown in Figure 1-4 or Figure 1-7) just enough to connect to the mating terminal block (TB2), shown in Figure 3-4. The mating terminal block can be pulled up and removed from its base to make the cable connection process easier.

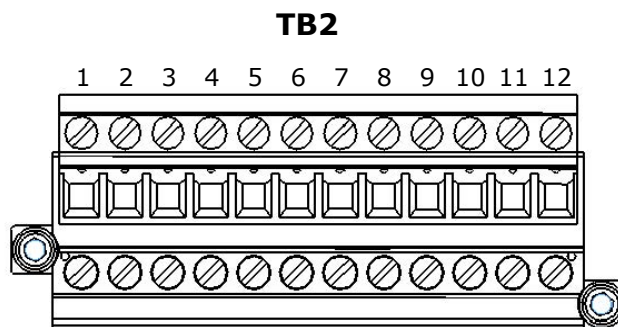

**Figure 3-4** Mating terminal block (TB2) in electronics enclosure for connecting signal cables

5. Connect the 4-20 mA current loop signal wires to the appropriate terminals, as indicated in Table 3-1.
6. Connect the serial cable wires to the appropriate terminals according to Table 3-1. For reference, Table 3-1 also shows the corresponding pin numbers for configuring a nine-pin Sub-D connector for connection to a computer serial port.

**Table 3-1** Output signal connections

Terminal	Description	D-Conn	Color
1	CH A Serial RX	Pin-3	Black
2	CH A Serial TX	Pin-2	Red
3	COM Serial Ground	Pin-5	Shield
4	N/C		
5	N/C		
6	CH A Current Loop +		
7	CH A Current Loop -		
8	N/C		
9	N/C		
10	N/C		
11	N/C		
12	N/C		

**NOTE:** The description "N/C" indicates no connection.

7. Connect the digital output relays according to the call-outs shown in Figure 1-6 or Figure 1-7.
8. Reinsert the mating terminal block into its base and verify that each connection is secure.
9. Close and tighten the electronics enclosure cover.

## Changing the 4-20 mA Current Loop Mode

By default, the 4-20 mA current loop output is factory set to source current. In some instances it may be necessary to change the 4-20 mA current loop output in the field from source to sink. The work must be performed by personnel qualified in electronics assembly.

### To change the 4-20 mA board from source to sink

1. Disconnect power to the analyzer and open the electronics enclosure cover. Take care not to disturb the electrical assembly inside.
2. Locate the 4-20 mA board(s) in the center of the electronics enclosure, as shown in Figure 1-6 or Figure 1-7.
3. Remove the jumper (JMP1), shown in Figure 3-5, connecting the center hole to point "A."

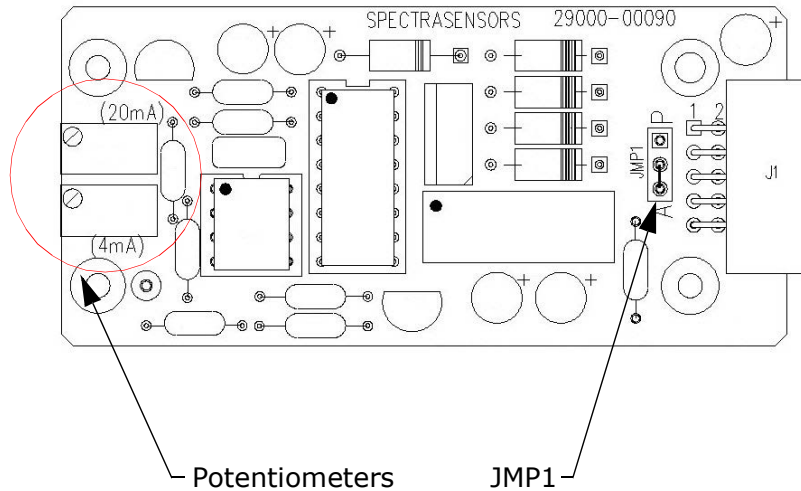

**Figure 3-5** 4-20 mA output board

4. For 4-20 mA sink, carefully replace the jumper to connect the center hole with point "P."



*Needle nose pliers may be required to remove the jumper.*

5. Repeat steps 2 to 4 as necessary for any remaining 4-20 mA boards.
6. Reconnect power to the analyzer. Confirm the 4 mA (min.) and 20 mA (max.) points. Close and tighten the electronics enclosure cover. Follow the programming instructions below.

### Calibrating the analog output

1. Connect a calibrator and digital multi-meter into the circuit.
2. On the analyzer keypad, press **#2 (Mode 2)**, the password (3142) and **\***.
3. Continue pressing the **\*** key until the **4-20 mA % Test** parameter displays.

```

<CH A SET PARAMETER>
4-20 mA % Test
101
Enter a % (101=Off)

```

4. Enter the desired percentage of full scale and press \*.
  - a. Set 4-20 mA % Test = 0; this displays the 4 mA on the AO circuit when **#1 (Mode 1)** is pressed.
  - b. Set 4-20 mA Test = 50; this displays the 12 mA on the AO circuit when **#1 (Mode 1)** is pressed.
  - c. Set 4-20 mA Test = 100; this displays the 20 mA on the AO circuit when **#1 (Mode 1)** is pressed.

### Testing and adjusting the 4-20 mA zero and span

1. Press **#1 (Mode 1)** and note the **4-20 mA % Test** parameter setting displayed on the analyzer.

<CH A SET PARAMETER>  
 4-20 mA % Test  
 0.0  
 Enter a % (101=Off)

2. Adjust the potentiometers on the end of the board to change the zero and span readings. Refer to Figure 3-5.
3. Press **#** and **1** to return to Normal Mode.

For more information on the analyzer programming, refer to the Description of Device Parameters.

## Connecting the Gas Lines

Consult the layout and flow diagrams in Appendix A for guidance. All work must be performed by technicians qualified in instrument tubing.



*Process samples may contain hazardous material in potentially flammable and/or toxic concentrations. Personnel should have a thorough knowledge and understanding of the physical properties and safety precautions for the sample contents before installing the gas lines.*

Using 1/4 in. O.D x 0.035 in. wall thickness, seamless electro-polished stainless steel tubing is recommended.

## To connect the sample supply line

1. First, confirm that the sample probe is correctly installed at the process supply tap and that the sample probe isolation valve is closed.



*Consult sample probe manufacturer instructions for proper installation procedures.*



*The process sample at the sample tap may be at a high pressure. Use extreme caution when operating the sample probe isolation valve and field pressure reducing regulator.*



*All valves, regulators, switches, etc. should be operated in accordance with site lock-out/tag-out procedures.*

2. Also, confirm that the field pressure reducing station is installed properly at the sample probe and that the pressure regulator at the field pressure reducing station is closed (adjustment knob turned fully counter-clockwise).
3. Determine appropriate tubing route from the field pressure reducing station to the sample conditioning system (SCS).
4. If configured with this analyzer, install the heat trace bundle in the heat trace sample inlet.
  - a. Remove the white foam supplied with the SCS.
  - b. Run the entire heat trace bundle into the enclosure.
  - c. Once installed, seal the rubber tube around the heat trace by applying heat until the tube shrinks down around the heat trace bundle.



***Hazardous voltage and risk of electric shock.*** Follow your plant safety guidelines or refer to your safety engineer before attempting to heat the rubber tube.

5. If configured with this analyzer, install the heat trace terminal box external to the SCS enclosure using the supplied GFI Heat Trace Power conduit hub.
  - a. Run the heat trace power back out of the enclosure and into the heat trace terminal box through the GFI Heat Trace Power conduit hub.

6. Run stainless steel tubing from the field pressure reducing station (set for the specified inlet pressure) to the sample supply port of the SCS. Bend tubing using industrial grade benders, check tubing fit to ensure proper seating between the tubing and fittings. Fully ream all tubing ends. Blow out the lines for 10 to 15 seconds with clean, dry nitrogen or air prior to making the connection.
7. Connect the inlet tube to the SCS using the 1/4 in. stainless steel compression-type fitting provided.
8. Tighten all new fittings 1-1/4 turns with a wrench from finger tight. For connections with previously swaged ferrules, thread the nut to the previously pulled up position, then tighten slightly with a wrench. Secure tubing to appropriate structural supports as required.
9. Check all connections for gas leaks. Using a liquid leak detector is recommended.



*Do not exceed 0.7 barg (10 PSIG) in sample cell. Damage to cell may result.*

---

### **To connect the sample return**

1. Confirm that the atmospheric vent header shut-off valve is closed, if applicable.



*All valves, regulators, switches, etc. should be operated in accordance with site lock-out/tag-out procedures.*

2. Determine appropriate tubing route from the SCS to the atmospheric vent header.
3. Run stainless steel tubing from the sample return port to the atmospheric vent header connection.
  - a. Bend tubing using industrial grade benders, check tubing fit to ensure proper seating between the tubing and fittings.
  - b. Fully ream all tubing ends.
  - c. Blow out the lines for 10 to 15 seconds with clean, dry nitrogen or air prior to making the connection.
4. Connect the sample return tube to the SCS using the 1/4 in. stainless steel compression-type fitting provided.
5. Tighten all new fittings 1-1/4 turns with a wrench from finger tight. For connections with previously swaged ferrules, thread the nut to

the previously pulled up position, then tighten slightly with a wrench. Secure tubing to appropriate structural supports as required.

6. Check all connections for gas leaks. Using a liquid leak detector is recommended.



*Do not exceed 0.7 barg (10 PSIG) in sample cell. Damage to cell may result.*

7. Be sure to vent the bypass return port and pressure relief vent port (if applicable) in a similar fashion when the unit is in use.

## Conditioning the SCS Tubing

Newly installed systems invariably have some trace contaminants and/or are intended for measuring trace amounts of gas constituents that tend to cling to system walls, which can result in erroneous readings if the constituents are not in equilibrium with the system walls. Therefore, once the analyzer and SCS are completely connected, the entire system (i.e., from the sample source valve to the vent or return) should be conditioned by flowing sample gas through the system for up to 12 hours (or until reading stabilizes) after the system is powered up and before actual readings are taken. Progress of the system conditioning can be monitored via the gas concentration readings. Once the gas constituents have reached equilibrium with the system walls, the readings should stabilize.



# 4 - SAMPLE CONDITIONING SYSTEM (SCS)

---



*Personnel should have a thorough understanding of the operation of the SS500/SS2000 analyzer and the procedures presented here before operating the sample conditioning system.*



*The process sample at the sample tap may be at a high pressure. A field pressure reducing regulator is located at the sample tap to reduce the sample pressure and enable operation of the sample conditioning system at a low pressure. Use extreme caution when operating the sample probe isolation valve and field pressure reducing regulator.*



*The process sample at the sample tap may be at a high pressure. Make sure that the field pressure reducing regulator is equipped with an appropriate pressure relief valve.*

SS500 and SS2000 systems may be ordered with an optional integrated sample conditioning system (SCS). Each SCS has been specifically designed to deliver a sample stream to the analyzer that is representative of the process stream at the time of sampling. To ensure the integrity of the sample stream and its analysis, care must be taken to install and operate the SCS properly. Therefore, any personnel intending to operate or service the analyzer and SCS should have a thorough understanding of the process application and the design of the analyzer and SCS.

Most problems experienced with sample systems tend to result from operating the system differently than intended. In some cases, the actual process conditions may be different than originally specified (e.g., flow rates, presence of contaminants, particulates, or condensables that may only exist under upset conditions). By establishing understanding of the application and the design of the system, most issues can be avoided altogether or easily diagnosed and corrected ensuring successful normal operation.

If there are any remaining questions concerning the design, operation, or maintenance of the SCS, contact Service. Refer to **"Service"** on page B-22.



*Process samples may contain hazardous material in potentially flammable and/or toxic concentrations. Personnel should have a thorough knowledge and understanding of the physical properties and safety precautions for the sample contents before operating the SCS.*

## About the SCS



*The system drawings and schematics found in Appendix A of this manual are for illustration purposes only. Always refer to the system drawings for your specific system configuration and specifications.*

Endress+Hauser offers two types of sample conditioning systems; a full-featured SCS (as shown in Table 4-1 on page 4-3), and a simplified sample system (as shown in Figure 4-2).

In the full-featured sample system, sample gas enters the sample conditioning system at the specified supply pressure set by an upstream regulator via the sample supply port. The sample passes through a shut-off valve, pressure regulator that maintains constant pressure in the measurement cell, and membrane separator where any liquid in the stream is removed. Liquid removed by the membrane separator passes through the bypass loop and collects in a filter housing. A continuous flow, set to the specified level by a metering valve with an integrated flow meter, not only flushes the liquid from the membrane separator, but also maintains flow through the sample lines.

In the simplified sample system, sample gas enters the sample conditioning system via the sample supply port inlet. The sample flows directly through the membrane separator where any liquid in the stream is removed. Pressure control and shut-off valves must be installed separately, upstream of the analyzer. Liquid removed by the membrane separator passes through the bypass loop. Part of the gas flow travels through the bypass to flush the liquid from the membrane separator. The bypass flow is controlled by a metering valve.

The flow exiting the bypass loop and the flow exiting the measurement cell is sent out to be vented to a safe location.

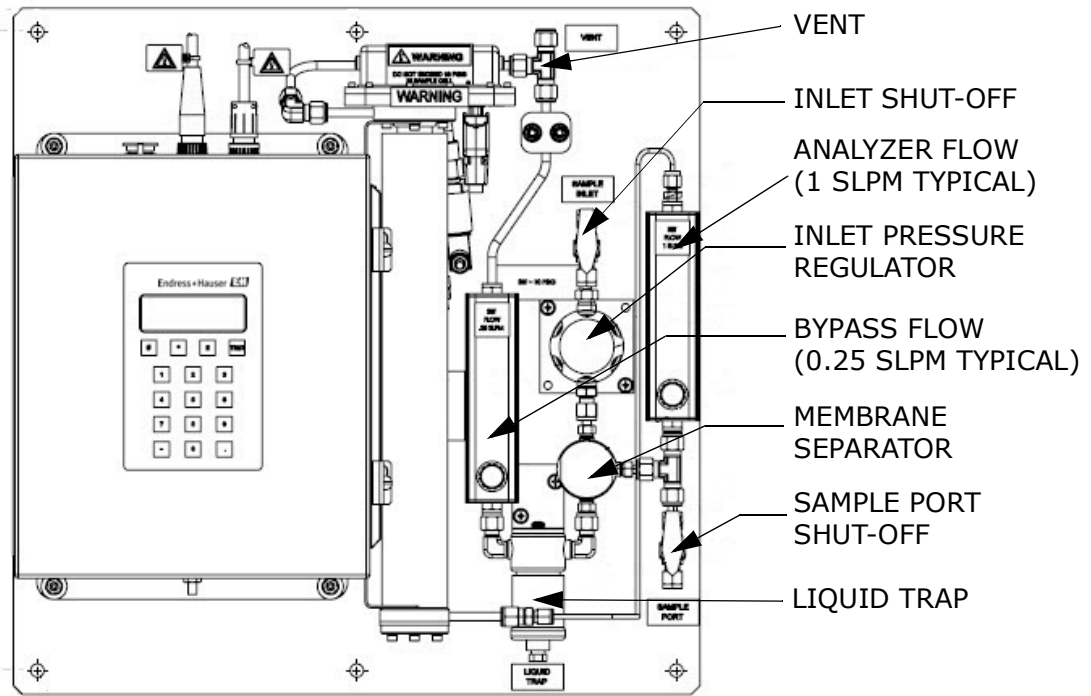

**Figure 4-1** SS500/SS2000 full-featured, single-channel SCS on a panel

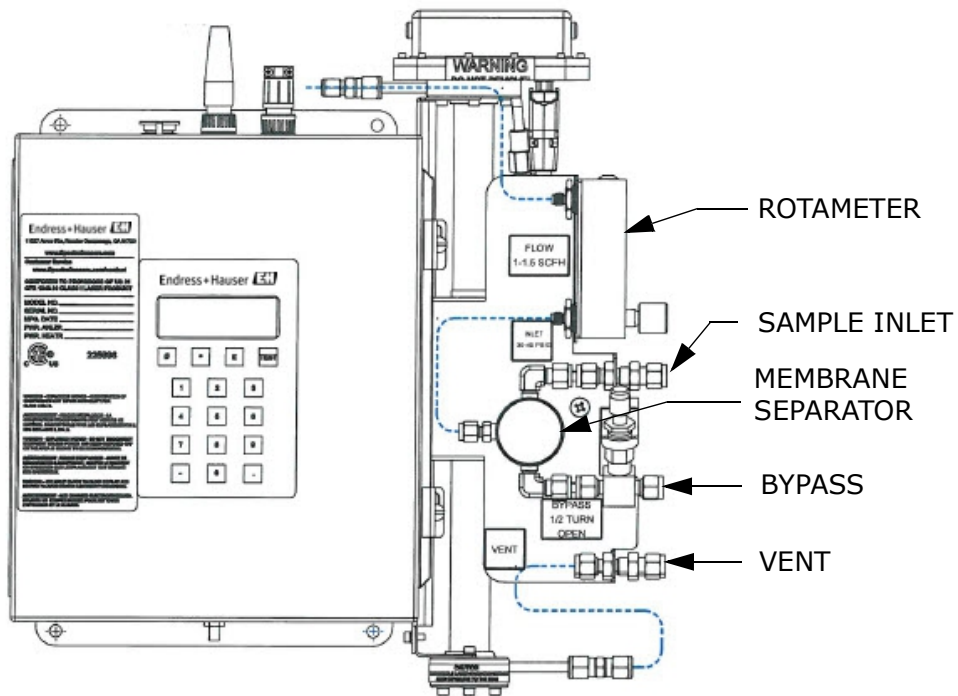

**Figure 4-2** SS500 with simplified, single-channel SCS on a panel

## Checking the SCS Installation

Before operating the sample system for the first time, a careful check of the installation of the entire SCS from the sample probe to the vent is recommended.

### To perform SCS installation checks

1. Confirm that the sample probe is correctly installed at the process supply tap and that the sample probe isolation valve is closed.
2. Confirm that the field pressure reducing station is installed properly at the sample probe.
3. Confirm that the relief valve at the field pressure reducing station has been set to the specified setpoint.
4. Confirm that all valves are closed.
5. Confirm that the power is available to the analyzer, and if applicable, that the local switch is off.
6. Confirm that the field analog and alarm signal wiring is connected properly (see **"To connect the output signals"** on page 3-8).
7. Confirm that the atmospheric vent is properly connected.
8. Confirm that the analyzer house atmospheric vent is properly installed, if applicable.
9. Confirm that all sample system tubing has been thoroughly leak checked.

## SCS Start-up

After the SCS installation has been thoroughly checked, you are ready to begin preparing for initial SCS startup.

### To prepare for SCS startup

1. If applicable, apply AC power to the heat-traced bundle sample transport tubing.



*If applicable, personnel should have a thorough understanding of the operation of the heat trace power supply and control system before operating the SCS.*

2. If applicable, confirm that the sample supply line heat traced temperature controller at the heat traced system is set to the temperature specified.

3. If applicable, confirm proper heating of the sample supply tubing.
4. Confirm that all sample system shut-off valves are closed.
5. Confirm that the sample bypass and analyzer flow meter control valves are gently closed (adjustment knob turned clockwise).



*Follow instruction for setting the flow meter control under the appropriate start up instruction for either the full-featured or simplified sample system configuration.*



*Do not overtighten the control valves or damage could occur.*

---

## **To start up the field pressure reducing station**

1. Confirm that the sample probe isolation valve is closed.



*The process sample at the sample tap may be at a high pressure. Use extreme caution when operating the sample probe isolation valve and field pressure reducing regulator.*

2. Confirm that the pressure regulator at the field pressure reducing station is closed (adjustment knob turned fully counterclockwise).
3. Slowly open the sample probe process shut-off valve at the sample supply tap.
4. Slowly open the pressure regulator at the field pressure reducing station (adjustment knob turned clockwise) and set the pressure regulator to the specified pressure.
5. Blow sample through the sample transport tubing to flare or safe vent to ensure that dirt or liquids are in the sample tubing.
6. Reconnect the sample transport tubing and set the pressure or the regulator to the specified pressure.

## **Starting up the full-featured sample system**

Use the following steps to start up the SS500/SS2000 with a full-featured sample conditioning system (SCS).

---

## To start up the sample bypass stream on process sample

1. Open the atmospheric vent header shut-off valve for the combined sample bypass and measurement cell effluent from the SCS, if applicable.
2. Open the sample supply port shut-off valve and slowly open the pressure regulator (turning knob clockwise).
3. Set the inlet pressure regulator on the panel to a setting that will maintain the specified flow meter settings and provide good control using the analyzer and bypass flow control valves.
4. Open the bypass flow meter control valve to establish sample flow from the sample probe and set the flow meter to the specified value.



*Flow meter pressure should never exceed 100 PSIG or a gas temperature over 100° F. Serious property damage and/or great personal injury could occur as the result of a misused meter or meter installed in an unsuitable application.*



*Do not exceed 10 PSIG at any time in the cell. Refer to Appendix A for analyzer specifications.*

---

## To start up the analyzer on process sample

1. Open the sample flow meter control valve to approximately the specified flow.
2. If required, adjust the pressure regulator at the field pressure reducing station to the specified setpoint.
3. Adjust the sample flow meter control valve to the specified flow.



*The adjustment setpoints of the analyzer flow meter and pressure regulator will be interactive and may require multiple adjustments until the final setpoints are obtained.*



*The analyzer system has been designed for the sample flow rate specified. A lower than specified sample flow rate may adversely affect analyzer performance. If you are unable to attain the specified sample flow rate, refer to "**Service**" on page B-22 for service information.*

4. Confirm the sample flow and pressure setpoints and readjust the control valves and pressure regulator to the specified setpoints, if necessary.

5. Confirm the sample bypass flow and readjust the bypass control valve to the specified setpoint, if necessary. The SCS is now operating with the process sample.
6. Power up the analyzer according to the procedure given in **"To power up the analyzer"** in the Description of Device Parameters.

## Starting up the Simplified Sample System

Use the following steps to start up the SS500 with a simplified sample conditioning system (SCS).

### To start up the simplified sample system



Refer to **"To start up the sample bypass stream on process sample"** for additional instruction.

1. Connect the bypass to vent line. Refer to Figure 4–3.

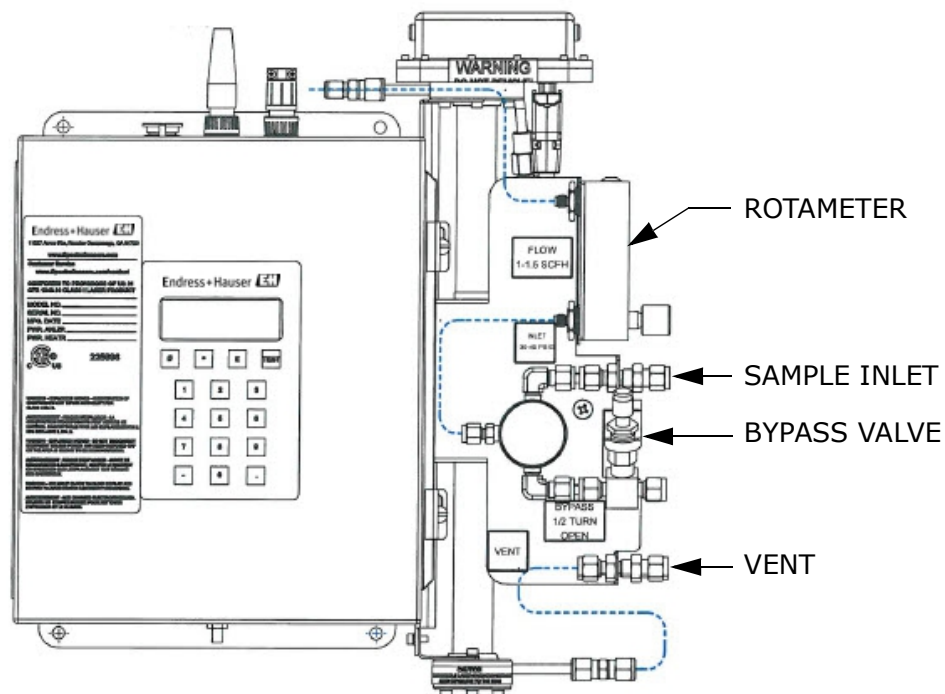

**Figure 4–3** Starting up the SS500 simplified sample system

2. Verify the rotameter is unlocked, then close by turning clockwise until it stops.

- Attach the supply line to the sample inlet and set the sample flow rate by adjusting the pressure of the supply to 30 to 40 PSIG.



*Do not exceed 60 PSIG at the sample inlet.*

- Adjust the rotameter for a cell flow of 1 to 1.5 SCFH.

If a test gas is used, nitrogen will show as 1 SCFH-AIR on the gauge. Refer to Figure 4-4 for a bypass flow diagram if alternate settings are required.

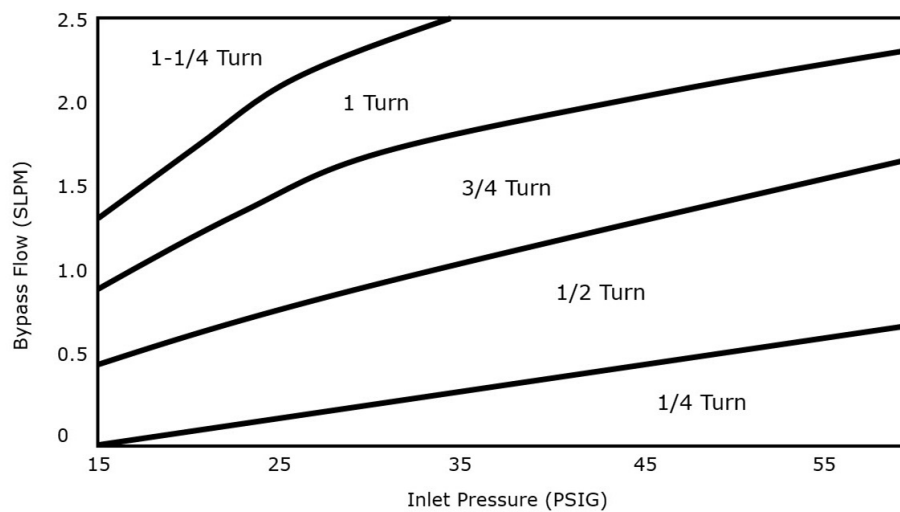

**Figure 4-4** Bypass flow diagram

- Open the rotameter by one-half turn to set the bypass flow to approximately 0.45 SLPM-AIR for a methane or light natural gas sample.



*The analyzer must always be operated with some gas flow in the bypass (needle valve open) or the membrane separator will not drain separated liquids. If liquids enter the cell, shut down the analyzer and remove the liquids. Refer to "**Service**" on page B-22 for information on removing liquids.*



## Shutting Down the SCS

The procedures discussed in this section apply to both the full-featured and simplified sample systems.



*Process samples may contain hazardous material in potentially flammable and/or toxic concentrations. Personnel should have a thorough knowledge and understanding of the physical properties and safety precautions for the sample contents before operating the SCS.*



*The process sample at the sample tap is at a high pressure. A pressure reducing regulator is located at the sample tap to reduce the sample pressure and enable operation of the SCS at a low pressure. Use extreme caution when operating the sample probe isolation valve and field pressure reducing regulator.*

---

### To isolate the analyzer for short-term shutdown (full-featured sample system)

The SS500/SS2000 full-featured analyzer can be isolated from the process sample tap for short-term shutdown or maintenance of the analyzer without requiring the shutdown of the field pressure reducing station.



*Process samples may contain hazardous material in potentially flammable and/or toxic concentrations. Personnel should have a thorough knowledge and understanding of the physical properties and safety precautions for the sample contents before operating the SCS.*



*Due to the high pressure of the process sample, it is advisable to allow the sample bypass flow to continue during short-term isolation of the analyzer. Continuing sample bypass flow allows the field pressure regulator to continue normal operation without possible overpressure and activation of the relief valve in the event the pressure regulator leaks when the downstream flow is discontinued.*



*The sample transport line must be vented to the atmospheric vent header through the bypass flow meter to avoid pressure surges. The procedure given in the following steps can be followed regardless of whether or not the SCS has been isolated from the process tap as described in the previous section.*



*All valves, regulators, switches, etc. should be operated in accordance with site lock-out/tag-out procedures.*

1. Close the sample supply shut-off valve.
2. Allow the sample to flow until all residual gas has dissipated from the lines as indicated by no flow on the sample and sample bypass flow meters.
3. If applicable, close the atmospheric vent header shut-off valve for the combined sample bypass and measurement cell effluent from the SCS.
4. Turn off power to the analyzer.



*If the system will not be out of service for an extended period, it is advised that power remain applied to the sample transport line heat trace, if applicable.*

### **To isolate the analyzer for long-term shutdown (full-featured sample system)**

If the SS500/SS2000 analyzer with full-featured sample system is to be out of service for an extended period, the analyzer must be isolated at the process sample tap.



*Process samples may contain hazardous material in potentially flammable and/or toxic concentrations. Personnel should have a thorough knowledge and understanding of the physical properties and safety precautions for the sample contents before operating the SCS.*



*Due to the high pressure of the process sample, it is advisable to allow the sample bypass flow to continue during long-term isolation of the analyzer. Continuing sample bypass flow allows the field pressure regulator to continue normal operation without possible overpressure and activation of the relief valve in the event the pressure regulator leaks when the downstream flow is discontinued.*



*The sample transport line must be vented to the atmospheric vent header through the bypass flow meter to avoid pressure surges. The procedure given in the following steps can be followed regardless of whether or not the SCS has been isolated from the process tap as described in the previous section.*



*All valves, regulators, switches, etc. should be operated in accordance with site lock-out/tag-out procedures.*

1. Open (or confirm open) the atmospheric vent header shut-off valve for the effluent from the SCS.
2. Confirm flow in the sample bypass flow meter (the actual flow is not critical).
3. Close the sample probe process shut-off valve at the sample supply process tap.
4. Allow pressure in the field pressure reducing regulator to dissipate until only a low residual pressure is indicated on the pressure gauge at the field station.
5. Close the field pressure reducing regulator (adjustment knob turned fully counterclockwise).
6. Close the sample supply shut-off valve.
7. Leave the flow meter control valves open.
8. Close the atmospheric vent header shut-off valve for the sample bypass and measurement cell effluent from the SCS.
9. Turn off power to the analyzer.
10. Turn off the AC power to the heat trace, if applicable, at the power distribution panel.



*Although power could be shut off to the sample supply heat trace, it is advisable to allow this line to remain heated unless the SCS is to be out of service for an extended period or maintenance is required on the line.*

---

### **To isolate the analyzer for shutdown (simplified sample system)**



*The sample transport line (installed by others) must be vented to the atmospheric vent header through the bypass flow meter to avoid pressure surges.*



*All valves, regulators, switches, etc. should be operated in accordance with site lock-out/tag-out procedures.*

1. Close the sample supply shut-off valve. Refer to Figure 4-5.

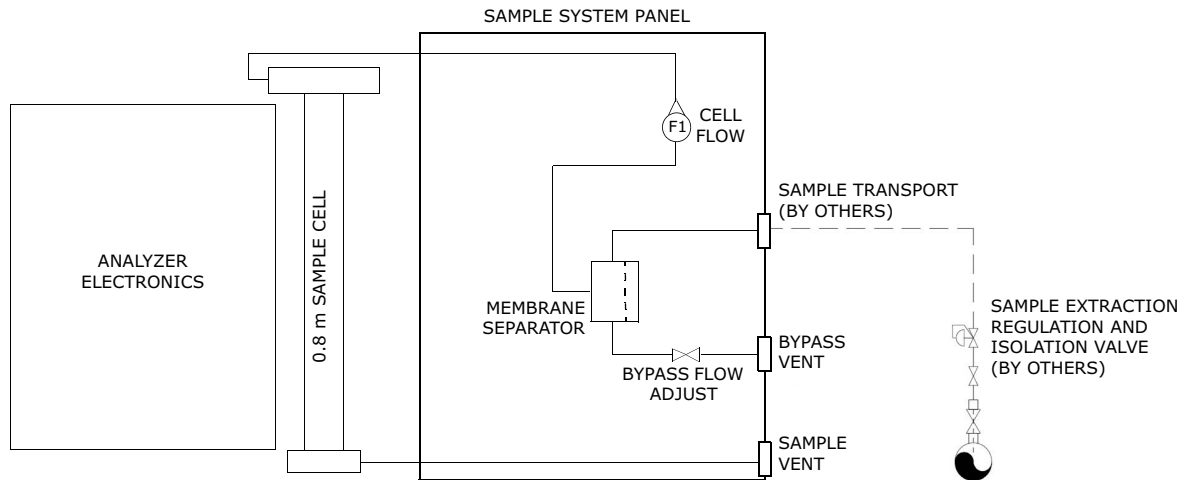

**Figure 4-5** Shutting of sample supply shut-off valve



A sample supply shut-off valve for the SS500 simplified sample system is recommended for this procedure, whether for short-term or long-term shutdown. This valve is to be installed by the customer upstream at the sample tap.



Process samples may contain hazardous material in potentially flammable and/or toxic concentrations. Personnel should have a thorough knowledge and understanding of the physical properties and safety precautions for the sample contents before operating the SCS.

2. Allow the sample to flow until all residual gas has dissipated from the lines as indicated by no flow on the sample and sample bypass flow meters.
3. Turn off power to the analyzer or begin maintenance procedure.



If the system will not be out of service for an extended period, it is advised that power remain applied to the sample transport line heat trace, if applicable, and that any vents are closed or protected to prevent any contamination.

# Appendix A: Specifications

**Table A-1** SS500/SS2000 analyzer specifications

Performance	
Concentration <sup>1</sup>	Refer to Calibration Report
Repeatability	Refer to Calibration Report
Accuracy	Refer to Calibration Report
Measurement Update Time <sup>2</sup>	1 second
Application Data	
Environmental Temperature Range	-20 to 50 °C (-4 to 122 °F)
Environmental Relative Humidity	5% to 95%, non-condensing
Altitude	Up to 2000 m
Maximum Cell Pressure	70 kPaG (10 PSIG)
Sample Cell Pressure Range	700 to 1400 mbara
Sample Flow Rate	0.5 to 1.0 SLPM (1 to 2 SCFH) typical
Recommended Validation	H <sub>2</sub> O: Bureau of Mines chilled mirror, portable TDL or binary gas with methane background. CO <sub>2</sub> : Binary cal gas with methane background. Refer to ASTM D7904.
Electrical & Communications	
Input Voltages <sup>3</sup>	100 to 240 VAC, 50/60 Hz 9 to 16 VDC or 18 to 32 VDC — <i>Optional</i>
Contact Rating (Inductive Load)	250V, 3A N.O. contact, 1.5A N.C. contact 24V, 1A N.O. and N.C. contact
Communication	<b>Analog:</b> (1 or 2) 4-20mA Isolated, 1200 ohms at 24VDC max load <sup>4, 5</sup> <b>Serial:</b> RS-232C <b>Protocol:</b> Modbus Gould RTU, Daniel RTU or ASCII
Digital Output	(2) General Fault and Assignable alarms
Physical Specifications (Analyzer) <sup>6</sup>	
System Dimensions	438.65 mm H x 370.59 mm W x 146.05 mm D (17.27 in. H x 14.59 in. W x 5.75 in. D)
Weight	Approximately 11.5 Kg (25 lbs)
Enclosure Type	NEMA 3R-304 Stainless Steel
Area Classification	
Certification	CSA Class I, Division 2, Groups A, B, C & D; T3C Class I, Zone 2 IIC T3C

1. Consult factory for alternative ranges.
2. Software adjustable.
3. Supply voltage not to exceed ±10% of nominal. Transient over-voltages according to Overvoltage Category II.
4. (1) 4-20 mA supplied standard with SS500; second 4-20 mA is optional.
5. (1) or (2) 4-20 mA provided with analyzer depending on configuration.
6. For analyzers sold with sample conditioning systems, refer to Table A-2 for sample conditioning system and enclosure specifications.

**Table A-2** SS500/SS2000 sample conditioning system specifications

<b>Physical Specifications SS500/SS2000 (Full-featured)</b>	
Sample Panel Dimensions <sup>1</sup>	504.95 mm H x 504.95 mm W x 146 mm D (19.88 in. H x 19.88 in. W x 5.75 in. D)
Weight	Approximately 13.60 Kg (30 lbs)
Sample Enclosure (24 in. x 24 in.) <sup>1</sup>	609.6 mm H x 609.6 mm W x 286.51 mm D (24 in. H x 24 in. W x 11.28 in. D)
Weight	Approximately 40.82 Kg (90 lbs)
Sample Enclosure (30 in. x 30 in.) <sup>1</sup>	609.6 mm H x 609.6 mm W x 286.51 mm D (24 in. H x 24 in. W x 11.28 in. D)
Weight	Approximately 54.43 Kg (120 lbs)
Enclosure Type	Type 4X-304 Stainless Steel
<b>Physical Specifications SS500 (Simplified)</b>	
Sample panel Dimensions <sup>1</sup>	421.64 mm H x 436.88 mm W x 184.15 mm (16.6 in. H x 17.2 in. W x 7.25 in. D)
Weight	Approximately 13.60 Kg (35 lbs)
Sample enclosure <sup>1</sup>	609.6 mm H x 609.6 mm W x 233.68 mm D (24 in. H x 24 in. W x 9.2 in. D)
Weight	Approximately 40.82 Kg (80 lbs)
Enclosure Type	Type 4X-304 Stainless Steel

1. This configuration specification includes the analyzer.

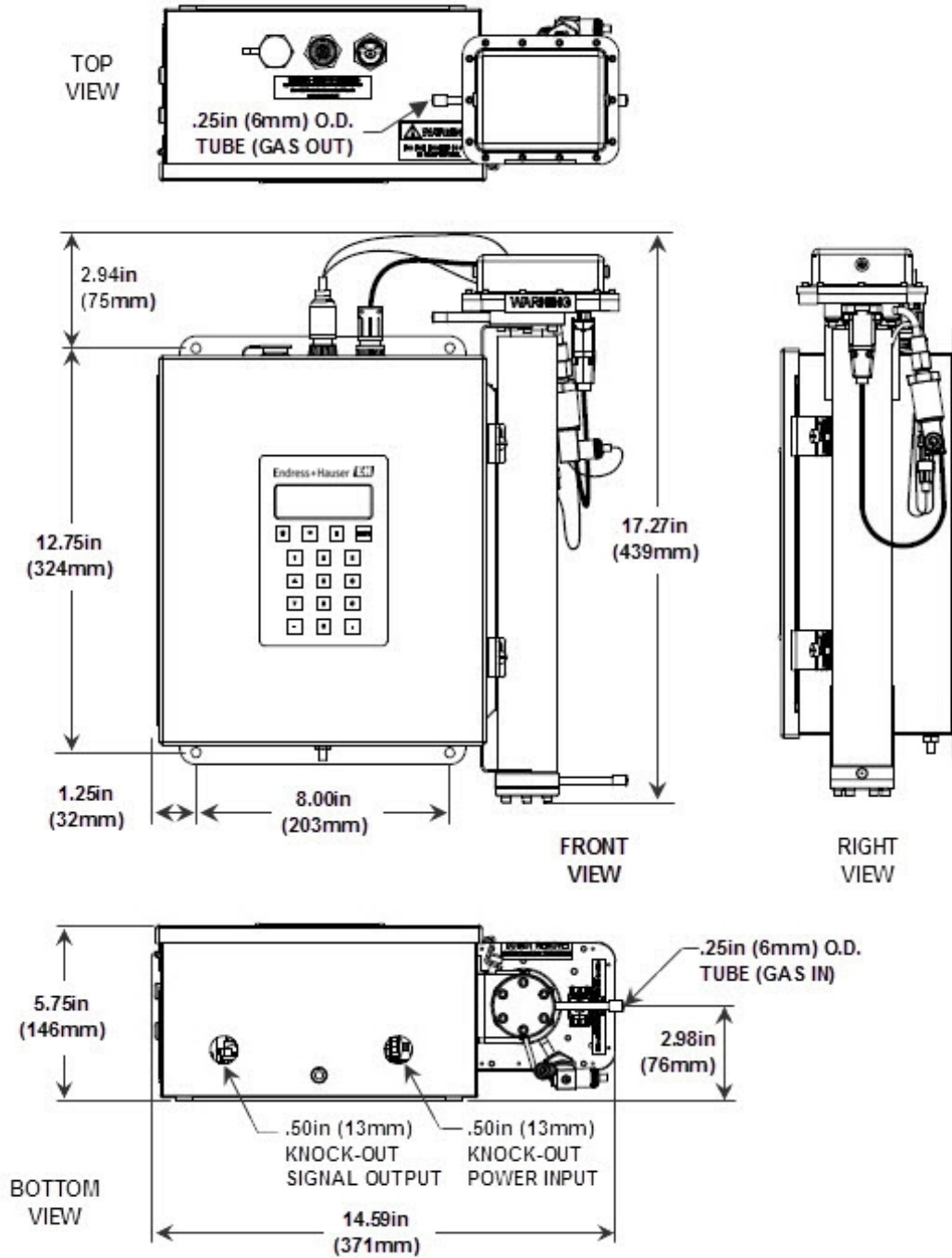

**Figure A-1** SS500/SS2000 0.8 m cell (moisture) outline and mounting dimensions

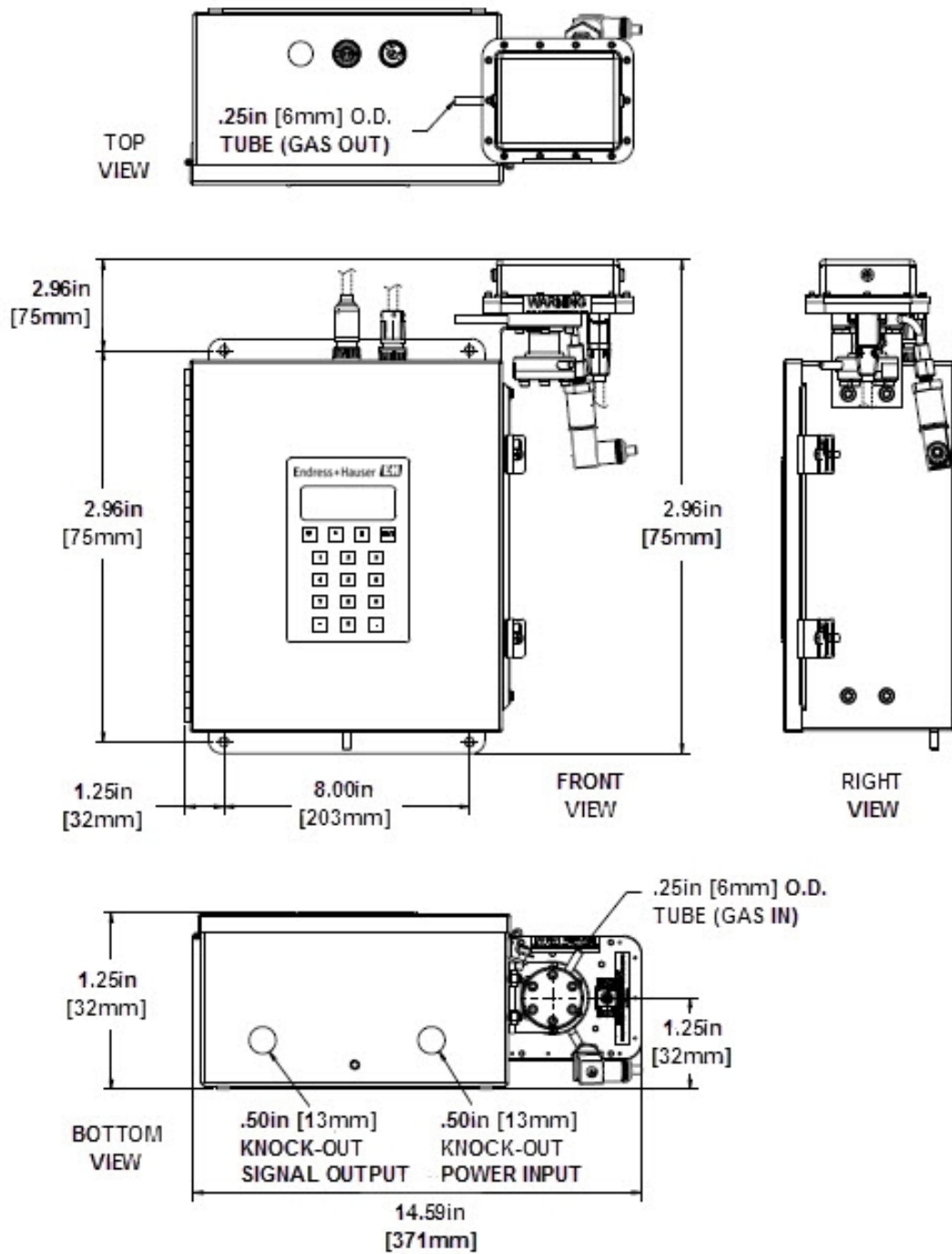

**Figure A-2** SS500/SS2000 0.1 m cell (carbon dioxide) outline and mounting dimensions



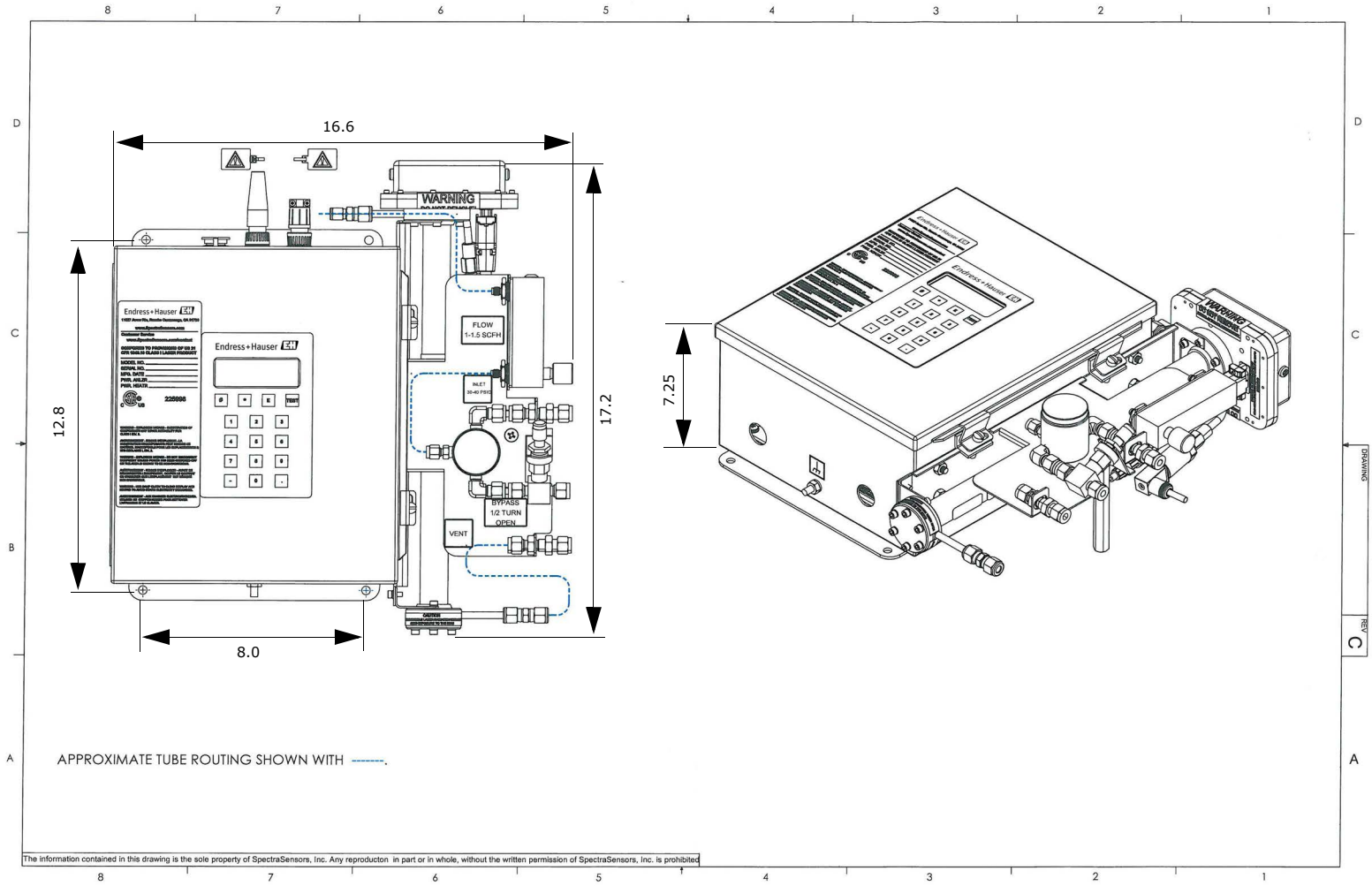
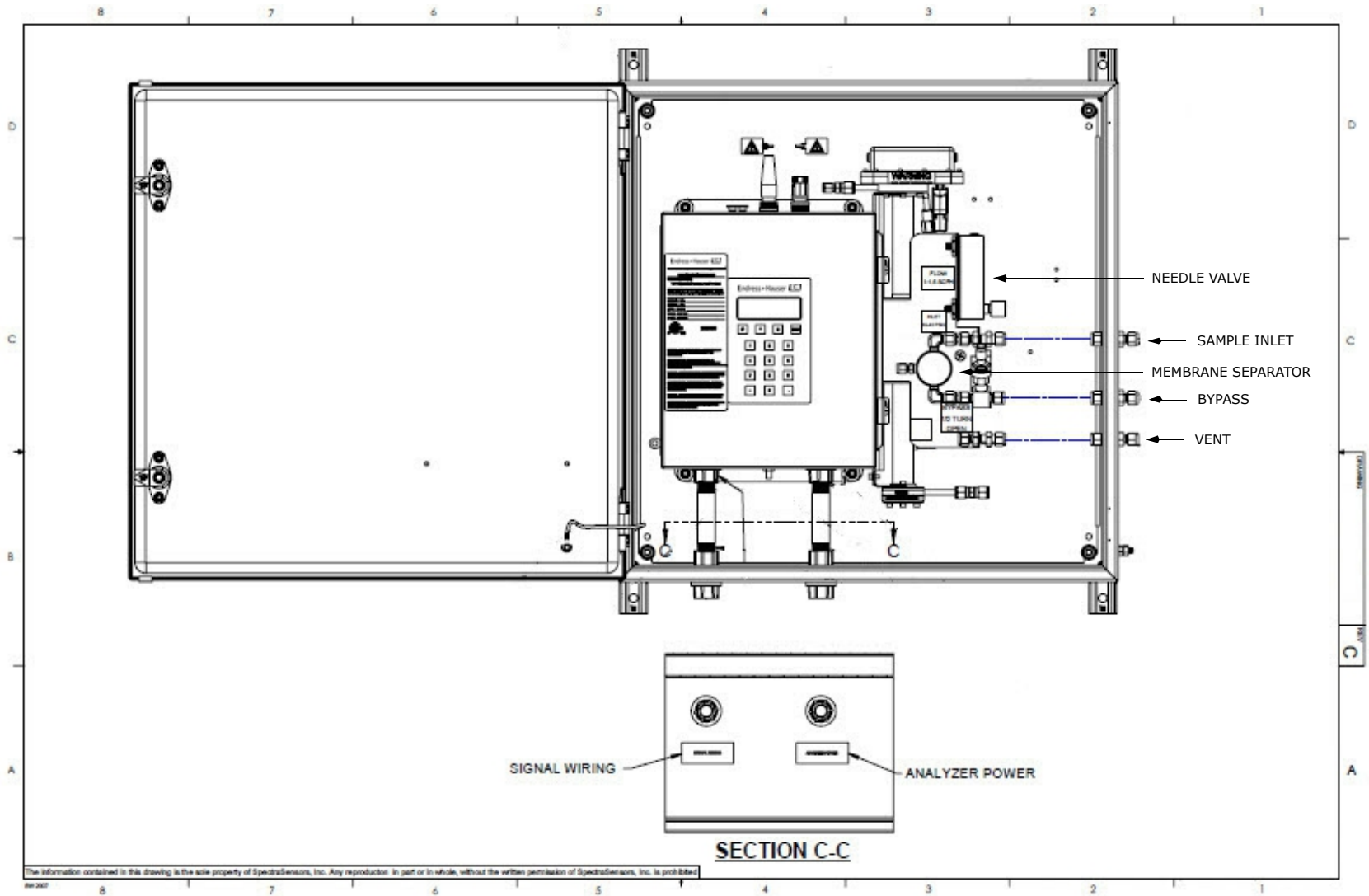
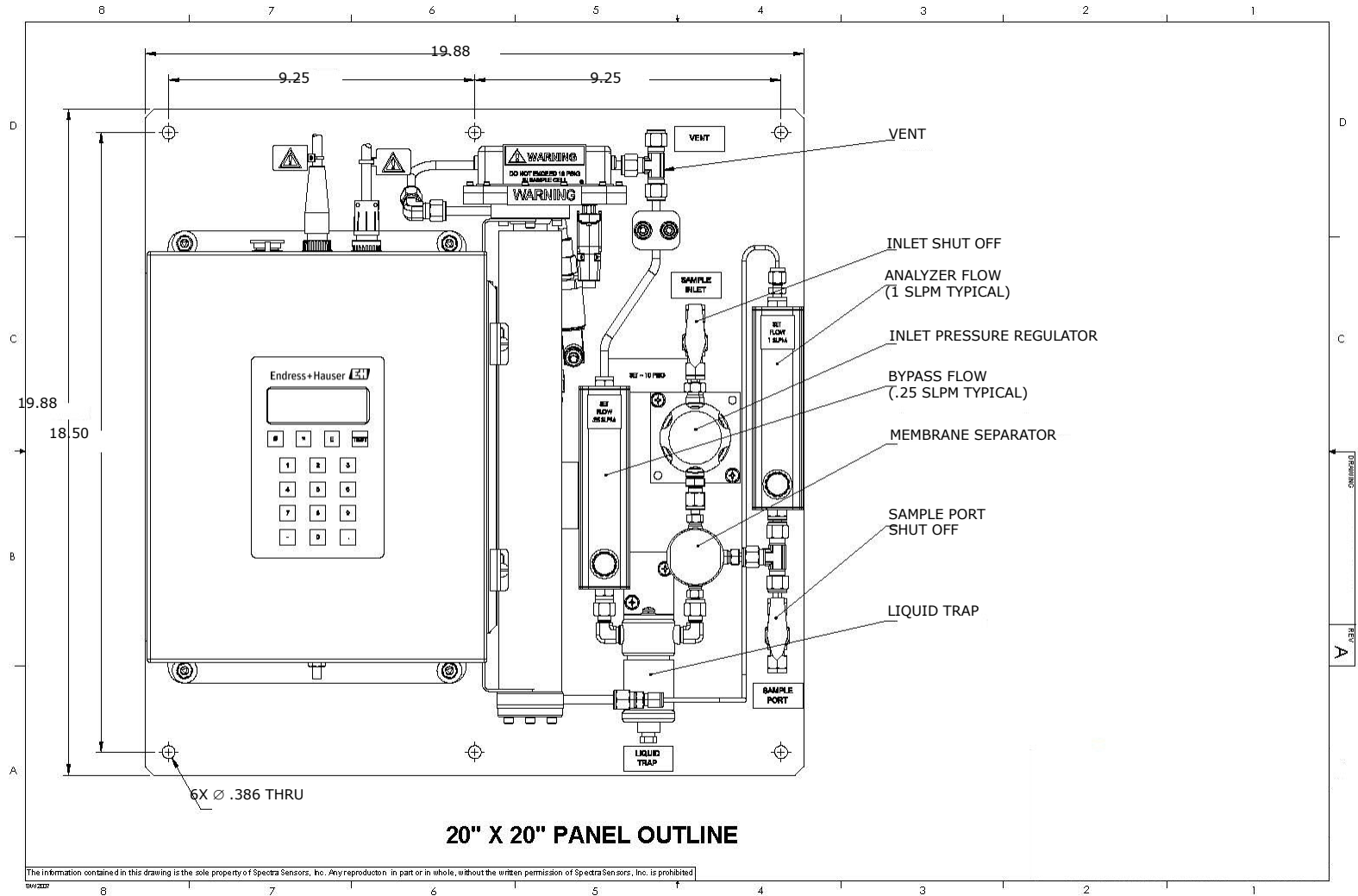

Figure A-3 Drawing of analyzer with simplified single-channel sample system (SS500)



**Figure A-4** Drawing of single-channel analyzer with simplified sample system in 24 in. x 24 in. enclosure (SS500)



**Figure A-5** Drawing of analyzer with full-featured single-channel sample system on a panel (SS500/SS2000)

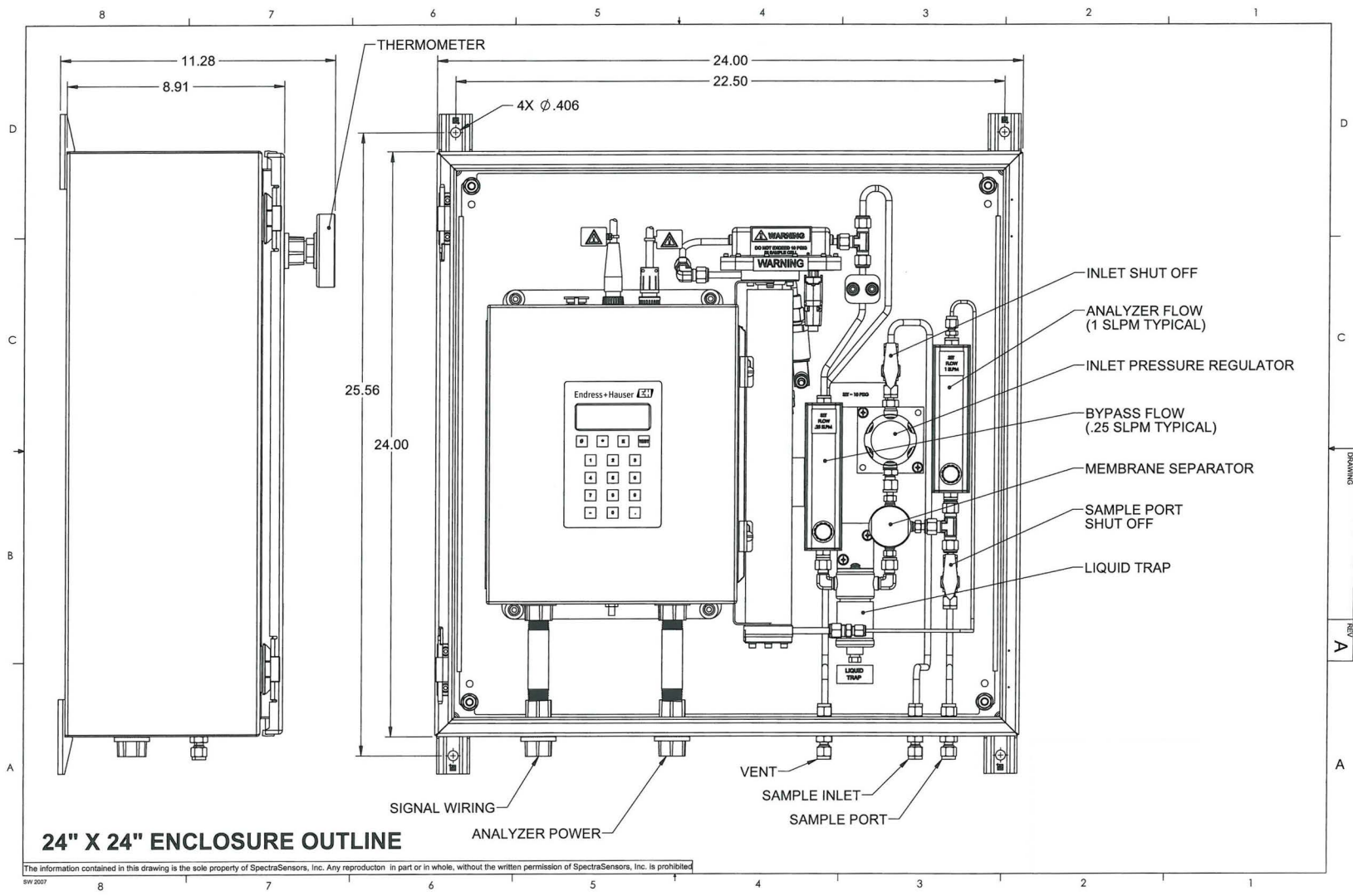

**Figure A-6** Drawing of analyzer with full-featured single-channel sample system in 24 in. x 24 in. enclosure (SS500/SS2000)

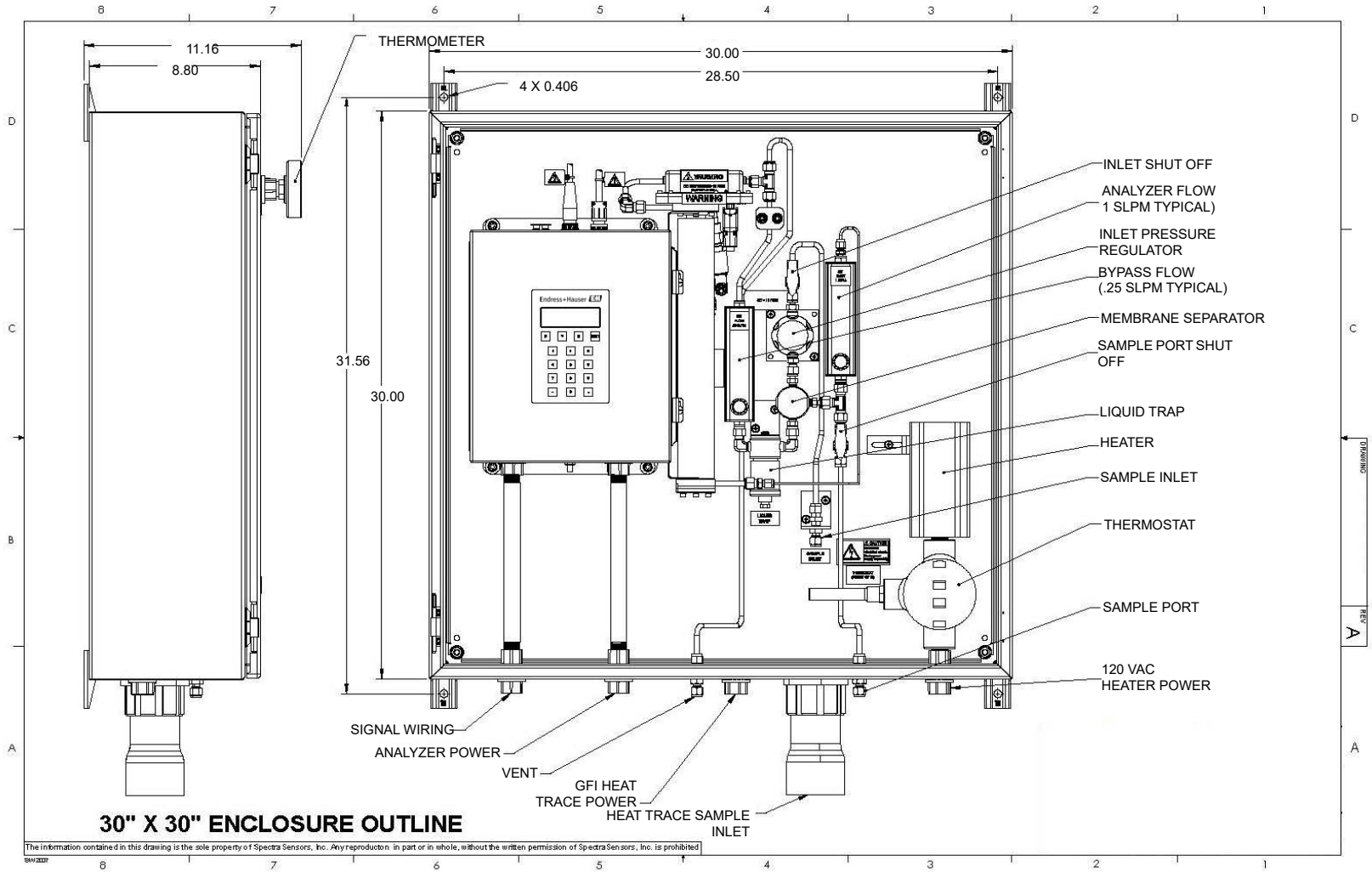

**Figure A-7** Drawing of analyzer with full-featured sample system in 30 in. x 30 in. enclosure with heat trace power (SS500/SS2000)

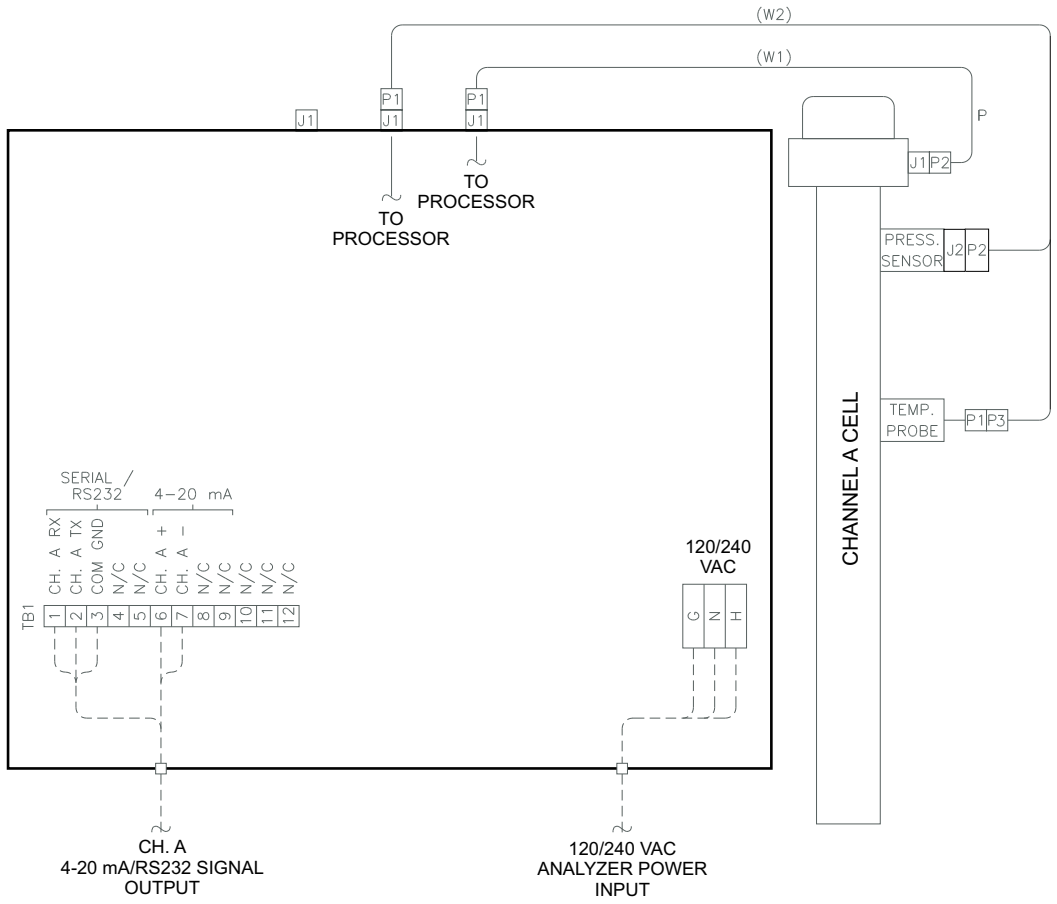

Figure A-8 Electrical schematic for SS500/SS2000

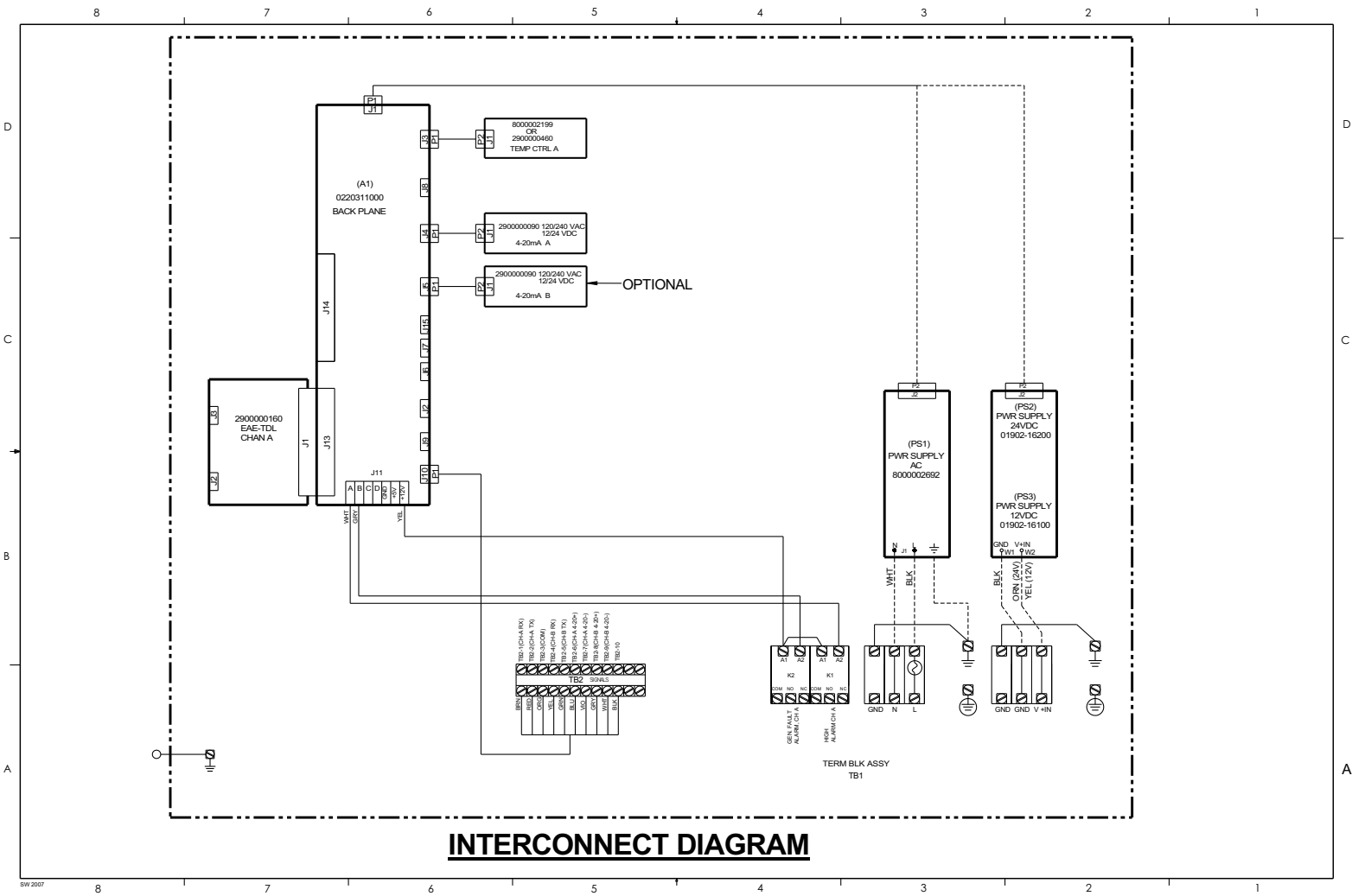

Figure A-9 Interconnect diagram for simplified single-channel system (SS500)

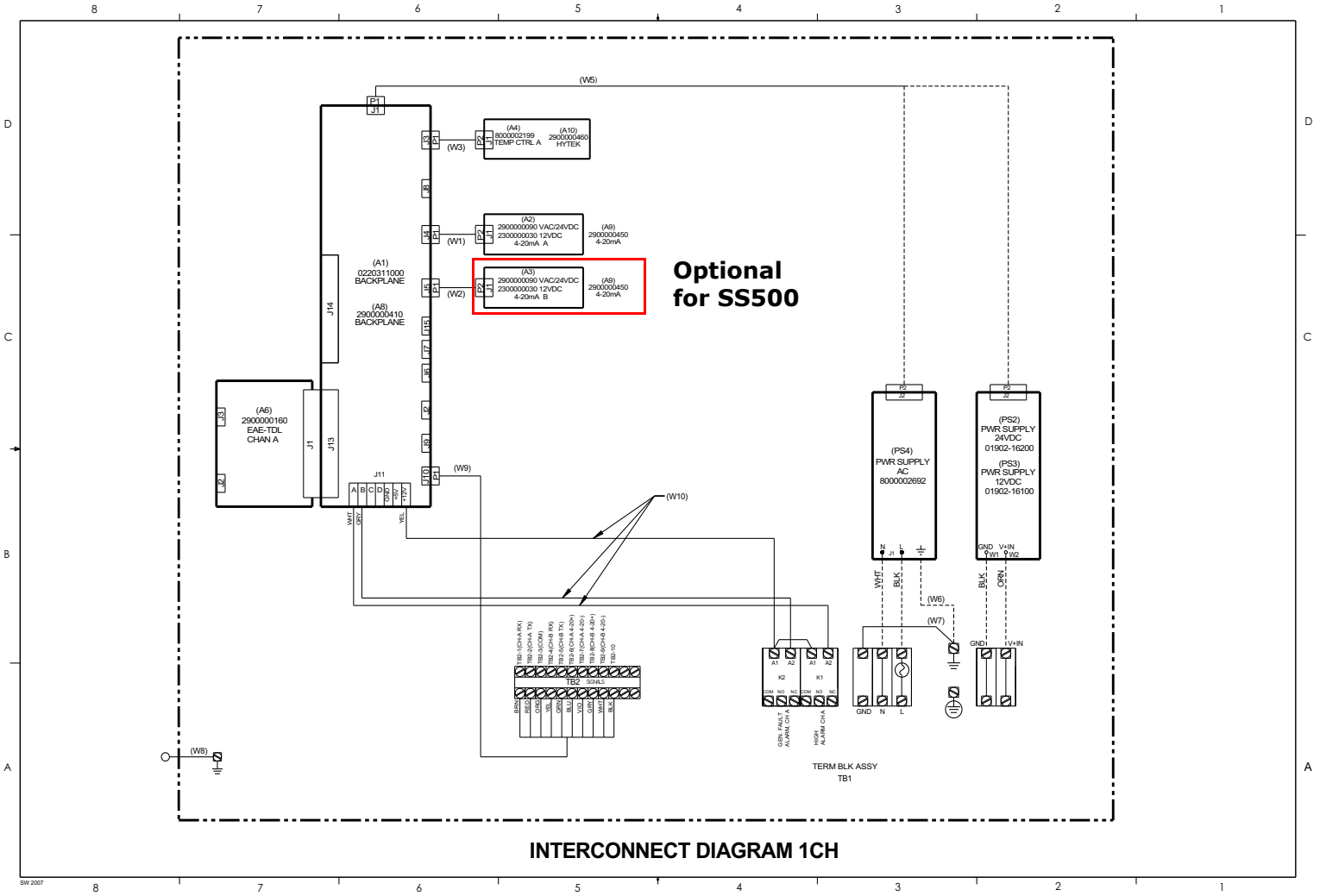

Figure A-10 Interconnect diagram for full-featured single-channel system (SS500/SS2000)



## Spare Parts

Below is a list of spare parts for the SS500/SS2000 analyzers with recommended quantities for 2 years of operation.

Due to a policy of continuous improvement, parts and part numbers may change without notice. Not all parts listed are included on every analyzer. When ordering, please specify the system serial number (SN) to ensure that the correct parts are identified.

**Table A-3** Replacement parts for SS500/SS2000

Part Number	Description	2 Year Quantity
<b>Electronics</b>		
0190217106	Cable, External, Serial (RS-232C)	1
8000002199	Temperature Control Board <sup>1</sup>	-
2900000450	4-20 mA Current Loop Board ( <i>not</i> for 12 VDC analyzer) <sup>1</sup>	-
2300000030	4-20 mA Current Loop Board (for 12 VDC analyzers) <sup>1</sup>	-
1100002128	Kit, 2nd 4-20 mA Current Loop Board ( <i>not</i> for 12 VDC) <sup>1</sup>	-
0190216300	Power Supply, 12 VDC <sup>1</sup>	-
0190216400	Power Supply, 24 VDC <sup>1</sup>	-
8000002692	Power Supply, 100-240 VAC 50/60 Hz, CSA <sup>1</sup>	-
0190230011	Keypad Assembly <sup>1</sup>	-
0190231000	Display Assembly <sup>1</sup>	-
0219900005	Kit, O-Rings Viton, 2-Pass Cell <sup>1</sup>	1
0219900011	Kit, Fuse, AC, DC	1
0900002146	Stainless Steel Mirror (0.1 m and 0.8 m cells only)	-
<b>Pressure Sensor Options</b>		
5500002041	Pressure Sensor, 30 PSIA, 5V, 1/8 in. MNPT DIN4365 NACE	1
6000002244	Cable, Pressure/Temperature, EXT, 22 in. <sup>1</sup>	1
<b>Maintenance</b>		
0219900001	Spares Kit, (O-Rings, Fuses), (Domestic U.S.)	1
0219900005	Spares Kit, (O-Rings, Fuses), (International)	-
0219900007	Cleaning Kit (Domestic U.S./Canada) <sup>1</sup>	1
0219900017	Cleaning Kit (International) <sup>1</sup>	1

1. Contact Service before attempting replacement. Replacing this component without technical support could cause damage to other components. Refer to "**Service**" on page B-22.

**Table A-3** Replacement parts for SS500/SS2000 analyzers (Continued)

Part Number	Description	2 Year Quantity
<b>Full-Featured Sample Conditioning Systems</b>		
61303042S4	Ball Valve, 1/4 in. TF (SS)	-
6100002193	Membrane & O-Ring, Membrane Separator	2
2800002057	Membrane Separator Cover O-Ring, Viton	1
6101671208	Membrane Separator, 1/4 in. FNPT (SS)	-
6134100274	Flow meter, 0-2 SLPM, Glass, Valve	-
6200002583	Pressure Regulator, 0 to 25 PSIG, 1/4 in. FNPT, Neon Controls	-
6101510004	Filter Housing, Mini SS/Glass	-
<b>Simplified Sample Conditioning Systems</b>		
6100002680	Membrane Separator, Type 6, 1/8 in. FNPT (SS/MTR)(SS500)	-
61305004MG	Valve, Metering, 1/4 TF, Cv0.04, (316SS)(SS500)	-
6100003138	Rotameter, 2.6 SCFH, Acrylic, 1/8 Tube, Valve, 54C (SS500)	-
6100002957	1/8 in. NPT to 1/8 in. Tube with Orifice	-
<b>Cables</b>		
0190217205	Harness Ribbon, 10 Cond., 9 in	-
0190217204	Cable, Power Supply Output, 14 in	-
0190217208	Cable, TE Cooler	-
0190217206	Cable, Signal Output	-
0190217101	Cable, External, Optical Head	-
0190217201	Cable, Internal, Optical Head	-
0190217202	Cable, Int, Temperature/Pressure	-
0190217211	Cable, Int, Temperature/Pressure, Dual	-
6000002221	Cable, 4X Relay Control, 9.5 in	-
6000002222	Cable, 2X Relay Control, 10 in	-
<b>General</b>		
BA02182C	SS500/SS2000 Operating Instruction, additional copies	-
GP01181C	Description of Device Parameters HC12 v2.51, additional copies	-



For a complete listing of new or updated certificates, please visit the product page at [www.endress.com](http://www.endress.com).

# Appendix B: Maintaining & Troubleshooting

---

This section presents recommendations and solutions to common problems, such as gas leaks, contamination, excessive sampling gas temperatures and pressures, and electrical noise. If your analyzer does not appear to be hampered by one of issues discussed in this chapter, refer to **"Service"** on page B-22.

## Gas Leaks

Probably the most common cause of erroneous measurements is outside air leaking into the sample supply line. It is recommended the supply lines be periodically leak-tested, especially if the analyzer has been relocated or has been replaced or returned to the factory for service and the sample lines have been reconnected.



*Do not use plastic tubing of any kind for sample lines. Plastic tubing is permeable to moisture and other substances which can contaminate the sample stream. Using 1/4 in. O.D x 0.035 in. wall thickness, seamless stainless steel tubing is recommended.*



*Process samples may contain hazardous material in potentially flammable and/or toxic concentrations. Personnel should have a thorough knowledge and understanding of the physical properties and safety precautions for the sample contents before operating the SCS.*

## Contamination

Contamination and long exposure to high humidity are valid reasons for periodically cleaning the gas sampling lines. Contamination in the gas sampling lines can potentially find its way to the sample cell and deposit on the optics or interfere with the measurement in some other way. Although the analyzer is designed to withstand some contamination, it is recommended to always keep the sampling lines as contamination free as possible. If mirror contamination is suspected, see **"Mirror Cleaning/Replacement"** on page B-3.

---

### To keep the sampling lines clean

1. Make sure that a membrane separator filter (included with most systems) is installed ahead of the analyzer and operating normally. Replace the membrane if necessary. If liquid enters the cell and accumulates on the internal optics, a **Power Fail Error** will result.

2. Turn off the sample valve at the tap in accordance with site lock-out, tag-out rules.
3. Disconnect the gas sampling line from the supply port of the analyzer.
4. Wash the sampling line with alcohol or acetone and blow dry with mild pressure from a dry air or nitrogen source.
5. Once the sampling line is completely free of solvent, reconnect the gas sampling line to the supply port of the analyzer.
6. Check all connections for gas leaks. Using a liquid leak detector is recommended.

## Excessive Sampling Gas Temperatures and Pressures

The embedded software is designed to produce accurate measurements only within the allowable cell operating range (see Appendix A). Pressures and temperatures outside these ranges will trigger a **P/T Fail Error** fault. Refer to the Description of Device Parameters for this analyzer for instruction on system faults.



*If the pressure, temperature, or any other readings on the LCD appear suspect, they should be checked against the specifications (see Appendix A).*

## Electrical Noise

High levels of electrical noise can interfere with laser operation and cause it to become unstable. Always connect the analyzer to a properly grounded power source. Refer to “**Protective chassis and ground connections**” on page 3-4.

## Powering Down the Analyzer

It may be necessary to power down the analyzer for problem solving or maintenance reasons. An approved switch or circuit breaker rated for 15 amps should have been installed and clearly marked as the disconnecting device for the analyzer.

### To power down the analyzer

1. Switch off the power to the analyzer using the switch or circuit breaker designated as the disconnection device for the equipment.
2. If the analyzer is going to be shut down for a short period of time for routine maintenance, isolate the analyzer from the SCS. Refer to

**“To isolate the analyzer for short-term shutdown (full-featured sample system)”** on page 4-9.

3. If the analyzer is going to be shut down for a long period of time, follow the procedure for isolating the process sample tap for long-term shutdown in **“To isolate the analyzer for long-term shutdown (full-featured sample system)”** on page 4-10. It is recommended to also disconnect the power completely from the analyzer to prevent potential damage from lightning strikes.

## Peak Tracking Reset Procedure

The analyzer’s software is equipped with a peak tracking function that keeps the laser scan centered on the absorption peak. Under some circumstances, the peak tracking function can get lost and lock onto the wrong peak.

Reset the peak tracking function if the difference between **PkDf** and **PkDI** is more than 4, or **Track Fail Error** is displayed. Refer to the Description of Device Parameters for this analyzer for instruction.

## Mirror Cleaning/Replacement

If contamination makes its way into the cell and accumulates on the internal optics, a **Power Fail Error** will result. If mirror contamination is suspected, please consult with your factory sales representative before attempting to clean the mirrors. If advised to do so, use the following procedure.



*Do not attempt to clean the cell mirror until you have consulted with your factory service representative and have been advised to do so. Refer to **“Service”** on page B-22 for service information.*



*The sample cell assembly contains a low-power, 10 mW MAX, CW Class 3b invisible laser with a wavelength between 700 to 3000 nm. Never open the sample cell flanges or the optical assembly unless the power is turned off.*



*Always handle the optical assembly by the edge of the mount. Never touch the coated surfaces of the mirror.*

---

## To determine the type of cell mirror

Measurement cells will come equipped with either a glass or stainless steel mirror. Before determining whether to clean or replace the mirror, identify the type of measurement cell being used in the analyzer. Analyzers will come equipped with one or more, depending on configuration, of the cell types shown in Figure B-1.

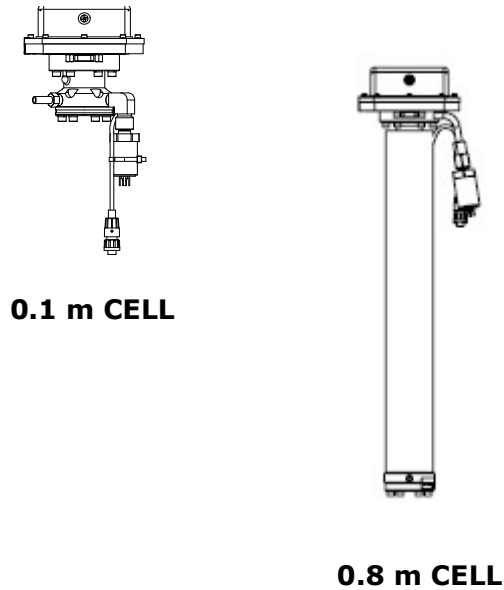

**Figure B-1** Measurement cell types

The stainless steel mirrors have been identified with either an "X" engraved on the external bottom side of the mirror or a groove around the rim of the mirror. Glass mirrors can be used on any size cell. To determine the type of mirror being used for the system cell:

1. Feel at the bottom of the cell for the engraved "X" marking or the side of the mirror for a groove. Refer to Figure B-2 below.

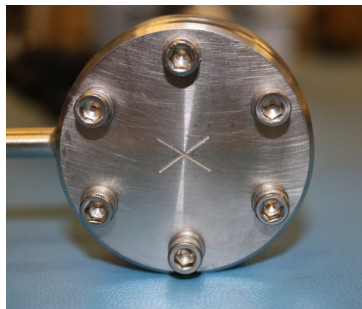

**MIRROR MARKED  
WITH 'X'**



**MIRROR GROOVED  
RIM — SIDE VIEW**

**Figure B-2** Stainless steel mirror marking

- a. If the bottom surface is smooth, a glass mirror is being used.
- b. If the bottom surface is rough or engraved, or a groove on the side of the mirror is detected, a stainless steel mirror is being used.



*Do not attempt to replace a glass mirror with a stainless steel mirror or system calibration may be adversely affected.*

To clean the glass mirror, refer to the instructions "**To clean the glass mirrors**" on page B-5. For "**To replace the stainless steel mirror**", refer to the instructions on page B-7.

## Tools and supplies

- Lens cleaning cloth (Cole Parmer® EW-33677-00 TEXWIPE® Alphawipe® Low-Particulate Clean Room Wipes or equivalent)
- Reagent-grade isopropyl alcohol (ColeParmer® EW-88361-80 or equivalent)



*Isopropyl alcohol can be hazardous. Follow all safety precautions when in use and thoroughly wash hands prior to eating.*

- Small drop dispenser bottle (Nalgene® 2414 FEP Drop Dispenser Bottle or equivalent)
- Acetone-impenetrable gloves (North NOR CE412W Nitrile Chemsoft™ CE Cleanroom Gloves or equivalent)
- Hemostat (Fisherbrand™ 13-812-24 Rochester-Pean Serrated Forceps)
- Bulb blower or dry compressed air/nitrogen
- Torque wrench
- Permanent marker
- Flashlight

## To clean the glass mirrors

1. Power down the analyzer following the procedure outlined in "**To power down the analyzer**" in the Description of Device Parameters for this analyzer.
2. Isolate the analyzer from the sample bypass flow. Refer to the procedure outlined in "**To isolate the analyzer for short-term shutdown (full-featured sample system)**" on page 4-9

**OR**

the procedure outlined in "**To isolate the analyzer for shutdown (simplified sample system)**" on page 4-11.

3. If possible, purge the system with nitrogen for 10 minutes.
4. Carefully mark the orientation of the mirror assembly on the cell body.



*Careful marking of the mirror orientation is critical to restoring system performance upon reassembly after cleaning.*

5. Gently remove the mirror assembly from the cell by removing the six socket-head cap screws and set on a clean, stable and flat surface.
6. Look inside the sample cell at the top mirror using a flashlight to ensure that there is no contamination on the top mirror.



*Due to its proximity to the optical head, Endress+Hauser does not recommend cleaning the top mirror. If the top mirror is visibly contaminated, contact your factory service representative.*

7. Remove dust and other large particles of debris using a bulb blower or dry compressed air/nitrogen. Pressurized gas duster products are not recommended as the propellant may deposit liquid droplets onto the optic surface.
8. Put on clean acetone-impenetrable gloves.
9. Double fold a clean sheet of lens cleaning cloth and clamp near and along the fold with the hemostats or fingers to form a "brush."
10. Place a few drops of isopropyl alcohol onto the mirror and rotate the mirror to spread the liquid evenly across the mirror surface.
11. With gentle, uniform pressure, wipe the mirror from one edge to the other with the cleaning cloth only once and only in one direction to remove the contamination. Discard the cloth.



*Never rub an optical surface, especially with dry tissues, as this can mar or scratch the coated surface.*

12. Repeat with a clean sheet of lens cleaning cloth to remove the streak left by the first wipe. Repeat, if necessary, until there is no visible contamination on the mirror.
13. For glass mirrors only, replace the mirror assembly onto the cell in the same orientation as previously marked.
14. Make sure the O-Ring is properly seated.
15. Tighten the 6 socket-head cap screws evenly with a torque wrench to **13 in-lbs**.



## To replace the stainless steel mirror

If your system has been configured with a stainless steel mirror in the 0.1 m or 0.8 m measurement cell, use the following instructions to replace the mirror, if necessary.



*If stainless steel mirrors are replacing another version of mirror in the field, such as glass, the analyzer may need to be returned to the factory for re-calibration to ensure optimal cell function. Refer to "**Service**" on page B-22.*

1. Power down the analyzer as instructed in the section called "**Powering Down the Analyzer**" on page B-2.
2. Isolate the analyzer from the sample bypass flow by shutting off the appropriate valve(s) and/or pressure regulator.



*All valves, regulators, switches, etc. should be operated in accordance with site lock-out/tag-out procedures.*



*Endress+Hauser recommends a sample supply shut-off valve for the SS500 simplified sample system. This valve is to be installed by the customer upstream at the sample tap.*

3. If possible, purge the measurement cell with nitrogen for 10 minutes.



*Process samples may contain hazardous material in potentially flammable and/or toxic concentrations. Personnel should have a thorough knowledge and understanding of the physical properties and safety precautions for the sample contents before operating the SCS.*

4. Gently remove the mirror assembly from the cell by removing the socket-head cap screws and set on a clean, stable and flat surface.



*The sample cell assembly contains a low-power, 10 mW MAX, CW Class 3b invisible laser with a wavelength between 750 to 3000 nm. Never open the sample cell flanges or the optical assembly unless the power is turned off.*



*Always handle the optical assembly by the edge of the mount. Never touch the optical surfaces of the mirror.*

5. Confirm need to replace mirror due to contamination. If yes, set mirror aside.
6. Obtain the new stainless steel mirror. Refer to Figure B-3.

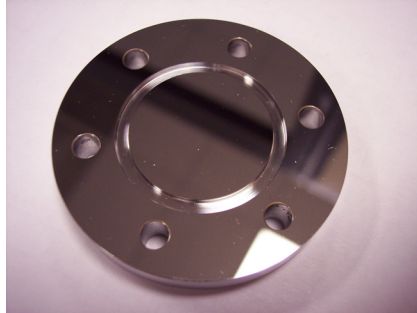

**Figure B-3** *Stainless steel mirror — mirror side up*

7. Check the O-Ring.
  - a. If a new O-Ring is needed, apply grease on fingertips and then to the new O-Ring.
  - b. Place newly greased O-Ring into the groove around the outside of the mirror taking care not to touch the mirror surface.
8. Carefully place the new stainless steel mirror onto the cell making sure the O-Ring is properly seated.
9. Tighten the socket-head cap screws evenly with a torque wrench to 13 in-lbs.

## Pressure Sensor Replacement

A pressure sensor may need to be replaced in the field as a result of one or more of the following conditions:

- Loss of pressure reading
- Incorrect pressure reading
- Pressure sensor not responding to pressure change
- Physical damage to the pressure sensor

Use the following information to replace a pressure sensor.

### Tools and materials

- Wrench, 9/16 in.
- Wrench, 7/8 in.
- Allen wrench, 9-64 in.
- Flat-head screwdriver
- Phillips-head screwdriver

- Metal pick
- Military grade stainless steel compatible PTFE tape (or equivalent)
- Dry nitrogen
- Isopropyl alcohol



*Isopropyl alcohol can be hazardous. Follow all safety precautions when in use and thoroughly wash hands prior to eating.*

## To replace the pressure sensor

1. Close the external flow of gas at the sample inlet.
2. Power off the system. Refer to **“Powering Down the Analyzer”** on page B-2.
3. Purge the system by connecting dry nitrogen to the sample inlet. Allow the SCS to purge for 5 to 10 minutes.
4. Close the nitrogen flow.
5. Remove the optical cable harness at the circular connector. Refer to Figure B-4.

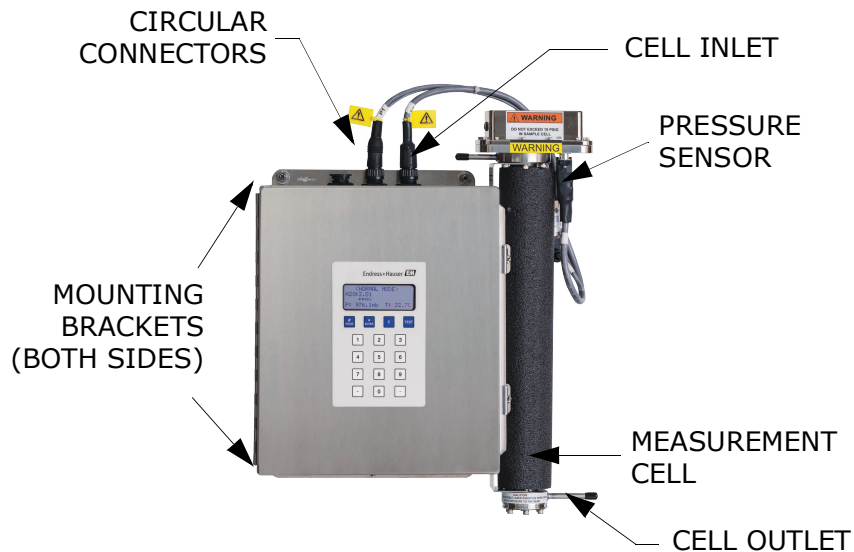

**Figure B-4** SS500/SS2000 analyzer component locations

6. Disconnect the cell inlet using a 9/16 in. wrench.
7. Disconnect the cell outlet using a 9/16 in. wrench.
8. Disconnect the thermistor cable at the circular connector.

9. Remove the pressure sensor cable from the circular connector.

For new model pressure sensors with quick-disconnects, detach the pressure sensor cable from the pressure sensor at the connector using a Phillips-head screwdriver. Do not remove the black connector from the cable.

10. Remove the foam insulation from around the measurement cell.
11. Remove the cell from the bracket by removing the four securing screws (four on top and four on the bottom) using a 9-64 in. Allen wrench. Place the measurement cell on a clean, flat surface with the pressure sensor facing up. Refer to Figure B-5.

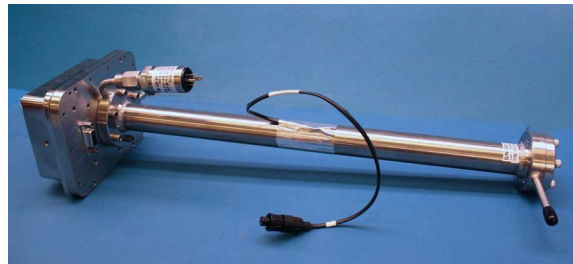
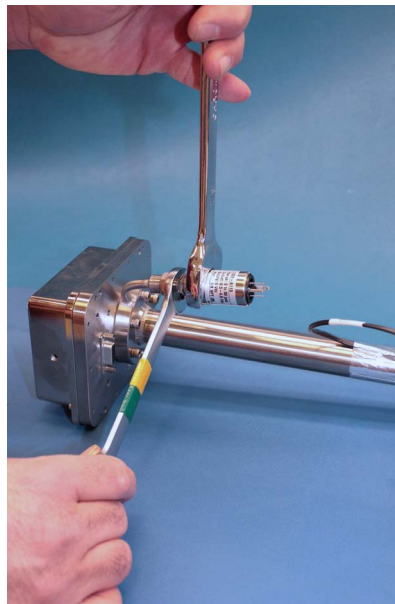

**Figure B-5** Removed measurement cell with pressure sensor face up



*Orient the measurement cell to avoid any debris from entering the cell.*

12. Using a 9/16 in. wrench, secure the flange while using a 7/8 in. wrench to remove the old pressure sensor. Refer to Figure B-6.



**Figure B-6** Removing the old pressure sensor

- a. Hold the supporting wrench on the flange stable and parallel to the surface. Do not move.
  - b. Turn the 7/8 in. wrench counterclockwise to loosen the pressure sensor until it is able to be removed.
13. Remove excess seal tape from the flange opening and threads and check galling. Refer to Figure B-7.



**Figure B-7** Removing excess seal tape from flange



Threads showing signs of galling indicate a possible leak. Refer to "Service" on page B-22 for information to arrange for repair.

14. Remove the new pressure sensor from the packaging. Retain the black connector cap on the sensor — *do not remove*.
15. Wrap stainless steel compatible PTFE tape around the threads at the top of the pressure sensor, beginning from the base of the threads to the top, approximately three times taking care to avoid covering the top opening. Refer to Figure B-8.



**Figure B-8** Replacing seal tape

16. Insert the new pressure sensor into the threaded flange keeping the sensor parallel to the surface for proper fitting.

17. Hand tighten pressure sensor clockwise into the flange until no longer moving freely. Refer to Figure B-9.

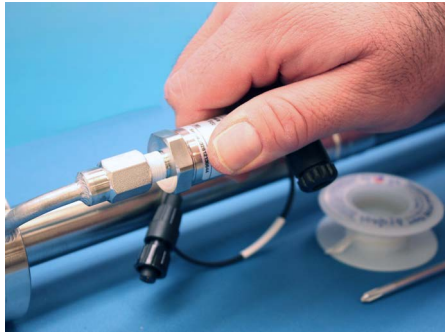

**Figure B-9** Replacing pressure sensor

18. Using the 9/16 in. wrench to hold the flange in place, turn the sensor clockwise with a 7/8 in. wrench until tight. Two or three threads on the pressure sensor should still be visible.



**Figure B-10** Newly installed pressure sensor positioning



*Make sure the black connector at the bottom of the pressure sensor is facing up from the measurement cell. Refer to Figure B-10.*

19. Remove the black connector from the pressure sensor and discard.
20. Connect the new harness/cable to the new pressure sensor.



*If the new model pressure sensor cable is currently installed in the SCS, reattach the cable to the pressure sensor after the cell has been remounted.*

21. Conduct a leak test to determine that the new pressure sensor is not leaking.



*Do not allow cell to exceed 10 PSIG or damage could occur.*



*For any questions related to leak testing the pressure sensor, refer to "**Service**" on page B-22.*

22. Remount the cell to the mounting brackets using a 9-64 in. Allen wrench with the pressure sensor facing forward.
23. Replace the foam insulation around the measurement cell.
24. Reinstall cell inlet and cell outlet using a 9/16 in. wrench.
25. Reconnect the thermistor.
26. Connect the new pressure sensor harness and cable to the circular connector.
27. Reconnect the optical cable harness.
28. Turn the system power on. Refer to the Description of Device Parameters for this analyzer for "**Powering up the analyzer.**"
29. Run a validation on the analyzer. Refer to the Description of Device Parameters for instructions to "**Start Validation.**"
  - a. If the system passes, the pressure sensor replacement is successful.
  - b. If the system does not pass, refer to "**Service**" on page B-22 for instruction.

## To unlock/set the flow meter

The flow meter is adjusted to the proper setting at the factory before shipment. Use the following procedure to re-set and lock the flow meter, if necessary.



*The flow meter is not designed for shut-off service.*



*Adjusting stop to a lower flow than the factory setting can damage the valve and the stem tip. Refer to "**Service**" on page B-22 for service information before attempting adjustment.*

## Tools

- 1/16 in. Hex key wrench
  - 0.050 in. Hex key wrench
1. Loosen the lock screw at the base of the handle using a 0.050 in. Hex key wrench. Refer to Figure B-11.

2. Loosen the handle screw with a 1/16 in. Hex key wrench and remove the handle from the valve. Set aside.
3. Adjust the stem to the desired handle stop position.



*Do not overtighten the stem in the body.*

4. Reposition the handle on the stem by aligning the handle screw with "flat" on the stem. Slide the handle down on the stem until the handle rests on top of the bonnet.

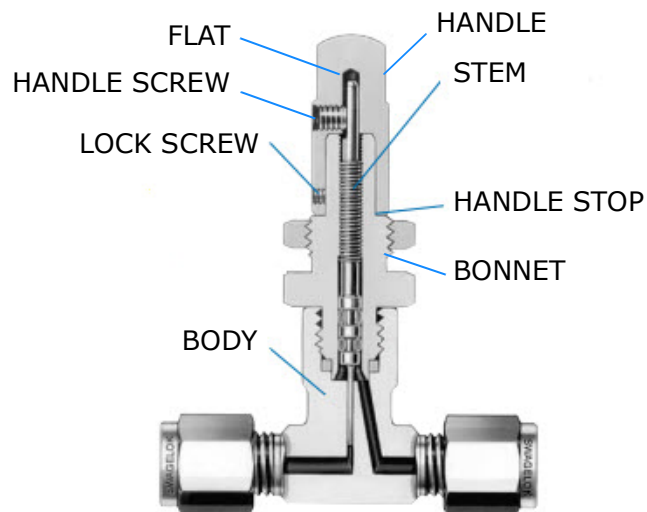

**Figure B-11** Setting/locking the needle valve

5. Tighten the handle screw to maintain the new handle stop position.
6. Test the valve for proper operation.
7. Lock in the flow setting by tightening the lock screw at the base of the handle using a 0.050 in. Hex key wrench, if necessary.

### **To replace the membrane separator filter**

Use the following steps to replace a membrane separator filter. Refer to Table A-3 on page A-13 for a list of spare parts.

1. Turn off the flow from the customer-installed shut-off valve at the sample tap.
2. Unscrew the cap from the membrane separator using a channel lock wrench.



3. Inspect the filter. Refer to Figure B-12.



**Figure B-12** *Inspecting the membrane separator filter*

If the membrane filter is dry:

4. Check if there are any contaminants or discoloring of the white membrane. If yes, the filter should be replaced.
  - a. Remove the O-Ring and replace the membrane filter.
  - b. Replace the O-Ring on top of the membrane filter.
  - c. Place the cap back onto the membrane separator and tighten.
5. Check upstream of the membrane for liquid contamination and clean and dry out before re-opening the shut-off valve at the sample tap.

**OR**

If the membrane filter is wet (liquid or contaminants are detected on the filter):

4. Drain any liquids and clean with isopropyl alcohol.
5. Clean any liquids or contaminants from the base of the membrane separator.
6. Replace the filter and the O-Ring.
7. Place the cap onto the membrane separator and tighten with a channel lock wrench.
8. Check upstream of the membrane for liquid contamination and clean and dry out before opening the shut-off valve at the sample tap.

### **To replace the rotameter (SS500 simplified sample system only)**

Use the following steps to replace the acrylic rotameter for the SS500 Simplified Sample System. Refer to Table A-3 on page A-13 for a list of spare parts.

## Tools

- Extra-thin open-end wrench, 5/8 in.
  - Extra-thin open-end wrench, 7/8 in.
  - Open-end wrench, 7/16 in.
1. Disconnect the tubing feeding into the rotameter by placing a 5/8 in. extra-thin open-end wrench on the flat of male thread closest to the tubing of the rotameter and use a 7/16 in. open-end wrench to loosen the nut. Complete this step for both the top and bottom connections. Refer to Figure B-13.

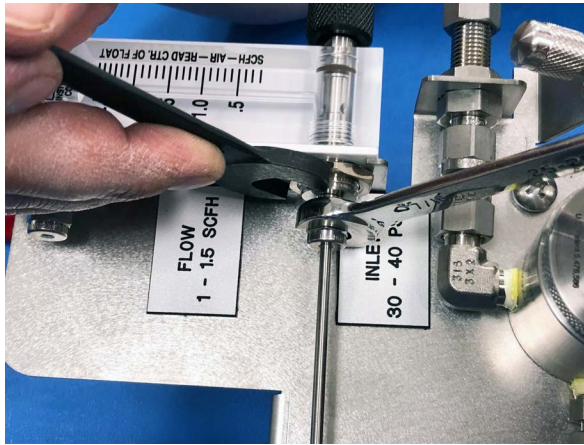

**Figure B-13** Disconnecting the rotameter

2. When disconnecting the rotameter, place one hand on the rotameter to brace it against the sample system panel and loosen the nut using a 7/8 in. extra-thin open-end wrench. Refer to Figure B-14.

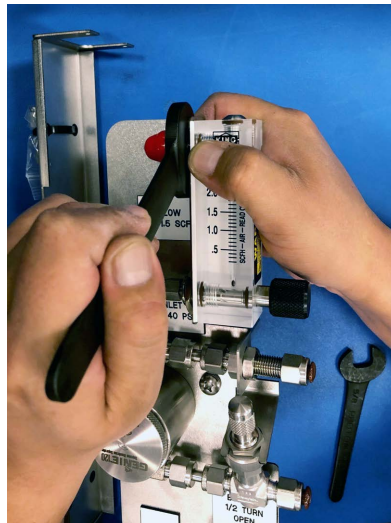

**Figure B-14** Stabilizing the rotameter for removal

3. Remove the tubing and lift the rotameter up and out of the bracket.
4. Loosen the tube nut, flat of male thread and washer on the new rotameter and insert into the bracket openings with the flat of male thread and washer on the inside of the bracket (analyzer side) and the white plastic base against the outside bracket edge.
5. Tighten the flat of male thread and washer to hand tight.
6. Use the 7/8 in. wrench to further tighten with a 1/8 turn to secure.
7. Reinstall the tubing into the inlet and outlet of the rotameter.
8. Tighten the tube nut with a 7/16 in. open-end wrench while holding the flat of male thread with the extra-thin 5/8 in. open-end wrench about a 1/8 turn.
9. Refer to the section called **"To start up the simplified sample system"** on page 4-7 to put the system back online.

## Periodic SCS Maintenance



*Due to the chemical properties of the process samples, care must be taken to repair or replace components with proper materials of construction. Maintenance personnel should have a thorough knowledge and understanding of the chemical characteristics of the process before performing maintenance on the SCS.*

The status of the SCS should be checked regularly to confirm proper operation (pressures, flows, etc.) and detect potential problems or failures before damage occurs. If maintenance is required, isolate the part of the system to be serviced by following the appropriate procedure under **"Shutting Down the SCS"** on page 4-9.

All filter elements should be checked periodically for loading. Obstruction of a filter element can be observed by a decreasing supply pressure or bypass flow. If loading of a filter is observed, the filter should be cleaned and the filter element replaced. After observation for some time, a regular schedule can be determined for replacement of filter elements.

No other regularly scheduled maintenance should be required for the system.

## Preventive and On-Demand SCS Maintenance



*Due to the chemical properties of the process samples, care must be taken to repair or replace components with proper materials of construction. Maintenance personnel should have a thorough knowledge and understanding of the chemical characteristics of the process before performing maintenance on the SCS.*

Preventive and on-demand maintenance will be required when components and parts deteriorate or fail as a result of continuous use. The performance of the entire SCS and individual components should be monitored regularly so that maintenance may be performed on a scheduled basis in order to prevent a failure that could take the system out of operation.

The SCS is designed for convenient removal and replacement of component parts. Complete spare components should always be available. In general, if a problem or failure occurs, the complete part should be removed and replaced to limit system down time. Some components may be repaired (replacement of seats and seals, etc.) and then reused.

If the sample supply line does not appear to completely clear during normal operation, it may be necessary to clean the sample transport line to remove any liquid that may adhere to the wall of the tubing. The sample transport line should be purged dry with air or nitrogen before the system is placed back in operation.



*The system must be taken out of service during any cleaning of the sample transport line.*

If liquid makes it into the analyzer SCS, a filter element may become obstructed leading to a decreasing supply pressure or bypass flow. If obstruction of a filter is observed, the filter should be cleaned and the filter element replaced.

### To perform regular SCS status check

1. Read and record the flow meter settings while the gas is flowing.
2. Compare the current readings with the past readings to determine any variations. Reading levels should remain consistent.
3. If reading levels decrease, check the filters.

### To check filters

1. Shut down the system following the procedure in **"Shutting Down the SCS"** on page 4-9.
2. Inspect, repair or replace the filter as required.



*For additional information, refer to **"Service"** on page B-22 for service information.*

3. Restart the system. Refer to **"Starting up the full-featured sample system"** on page 4-5 or **"Starting up the Simplified Sample System"** on page 4-7.

## Instrument Problems

If the instrument does not appear to be hampered by gas leaks, contamination, excessive sampling gas temperatures and pressures, or electrical noise, refer to Table B-1 before contacting Customer Service.

**Table B-1** Potential instrument problems and solutions

Symptom	Response
Non-Operation (at start up)	Is the power connected to both the analyzer and power source? Is the switch on?
Non-Operation (after start up)	Is the power source good? (100 to 250 VAC at 50 to 60 Hz, 9 to 16 VDC, 18 to 32 VDC).
	Check fuse(s). If bad, replace with equivalent amperage, slow-blow fuse.
	Refer to " <b>Service</b> " on page B-22 for service information.
<b>Power Fail Error</b>	Turn off the power to the unit and check the optical head cables for a loose connection. <b>Do not disconnect or reconnect any optical head cables with the power connected.</b>
	Refer to the Description of Device Parameters for this analyzer to verify a Power Fail error.
	Check the inlet and outlet tubes to see if they are under any stress. Remove the connections to the inlet and outlet tubes and see if the power goes up. The existing tubing may need to be replaced with stainless steel flexible tubing.
	Possible mirror contamination issue. Refer to " <b>Service</b> " on page B-22 for service information. If advised to do so, clean the mirrors by following the instructions under " <b>To clean the glass mirrors</b> " on page B-5.
	Possible alignment problem. Refer to " <b>Service</b> " on page B-22.
	Capture diagnostic data and send the file to Service (see " <b>To read diagnostic data with HyperTerminal</b> " in the Description of Device Parameters for this analyzer).

**Table B-1** Potential instrument problems and solutions (Continued)

Symptom	Response
<b>Null Fail Error</b>	Refer to the Description of Device Parameters for this analyzer for instruction on verifying or clearing a <b>Null Fail Error</b> fault.
	Capture diagnostic data and send the file to Endress+Hauser (see <b>"To read diagnostic data with HyperTerminal"</b> in the Description of Device Parameters for this analyzer).
<b>Spectrum Fail Error</b>	Turn off the power to the unit and check the optical head cables for a loose connection. <b>Do not disconnect or reconnect any optical head cables with the power connected.</b>
	Turn the analyzer off for 30 seconds and then turn it on again.
	Reset the peak tracking. Refer to <b>"Peak Tracking Reset Procedure"</b> on page B-3.
	Capture diagnostic data and send the file to Endress+Hauser (see <b>"To read diagnostic data with HyperTerminal"</b> in the Description of Device Parameters for this analyzer).
<b>P/T Fail Error</b>	Check that the actual pressure in the measurement cell is within specification (see Appendix A).
	Check that the actual temperature in the measurement cell is within specification (see Appendix A).
	If the temperature reading is incorrect, check that the pressure/temperature cable is tight. Check the connector on the cell temperature sensor. Check the temperature connector on the backplane board. ( <b>Note:</b> A temperature reading greater than 150 °C indicates a short circuit on the temperature sensor leads; a reading of less than -40 °C indicates an open circuit).
	If the pressure reading is incorrect, check that the pressure/temperature cable is tight. Check the connector on the pressure sensor. Check the pressure connector on the backplane board.

**Table B-1** Potential instrument problems and solutions (Continued)

Symptom	Response
Current loop is stuck at 4 mA or 20 mA	Check display for fault message. If alarm has been triggered, reset the alarm.
	On the current loop board, check the voltage between the end of resistor R1 closest to the jumper and ground. If the concentration reading is high, the voltage should be near 1 VDC. If the concentration reading is low, the voltage should be near 4.7 VDC. If not, the problem is probably on the HC12 main board. Return to factory for service, refer to <b>"Service"</b> on page B-22.
Reading seems to always be high by a fixed amount	See <b>"Adjusting Analyzer Reading to Match Specific Standard(s)"</b> in the Description of Device Parameters for this analyzer.
	Capture diagnostic data and send the file to Endress+Hauser (see <b>"To read diagnostic data with HyperTerminal"</b> in the Description of Device Parameters for this analyzer).
	Perform a validation. Refer to <b>Mode 7</b> or <b>"Validating the Analyzer"</b> in the Description of Device Parameters.
Reading seems to always be high by a fixed percentage	See <b>"Adjusting Analyzer Reading to Match Specific Standard(s)"</b> in the Description of Device Parameters of this analyzer.
	Capture diagnostic data and send the file to Endress+Hauser (see <b>"To read diagnostic data with HyperTerminal"</b> in the Description of Device Parameters for this analyzer).
	Perform a validation. Refer to <b>Mode 7</b> or <b>"Validating the Analyzer"</b> in the Description of Device Parameters.
Reading goes to "0"	If <b>4-20 mA Alarm Action</b> is set to <b>0</b> , look on display for a fault message (see <b>"To change parameters in Mode 2 or Mode 3"</b> in the Description of Device Parameters for this analyzer).
	Actual gas concentration may be equal to zero. Perform validation using <b>Mode 7</b> or <b>"Validating the Analyzer"</b> in the Description of Device Parameters.

**Table B-1** Potential instrument problems and solutions (Continued)

Symptom	Response
Reading goes to full scale	If <b>4-20 mA Alarm Action</b> is set to <b>1</b> , look on display for a fault message (see <b>"To change parameters in Mode 2 or Mode 3"</b> in the Description of Device Parameters for this analyzer).
	Gas concentration may be greater than or equal to full scale value. Perform validation using <b>Mode 7</b> or <b>"Validating the Analyzer"</b> in the Description of Device Parameters.

## Service

For Service in your area, refer to our website for the list of local sales channels (<https://www.endress.com/contact>).

### Before contacting Service

Before contacting Service, prepare the following information to send with your inquiry:

- Analyzer serial number (SN)
- Diagnostic downloads using the procedures provided in the associated Description of Device Parameters or using AMS100 software from Endress+Hauser
- Contact information
- Description of the problem or questions

Access to the information above will greatly expedite our response to your technical request.

### Service repair order

If returning the unit is required, obtain a **Service Repair Order (SRO) Number** from Customer Service before returning the analyzer to the factory. Your service representative can determine whether the analyzer can be serviced on site or should be returned to the factory. All returns should be shipped to:

Endress+Hauser  
 11027 Arrow Rte.  
 Rancho Cucamonga, CA 91730-4866  
 United States of America  
 1-909-948-4100



## Renewity returns

Returns can also be made inside the USA through the Renewity system. From a computer, navigate to <http://www.us.endress.com/return> and complete the online form.

## Packing

Endress+Hauser analyzer systems and auxiliary equipment are shipped from the factory in appropriate packaging. Depending on the size and weight, the packaging may consist of a cardboard-skinned container or a wooden crate. All inlets and vents are capped and protected when packaged for shipment.

If the equipment is to be shipped or stored for any length of time, it should be packed in the original packaging when shipped when shipped from the factory, if possible. If the analyzer has been installed and or operated (even for purposes of a demonstration), the system should first be decontaminated (purged with an inert gas) before powering down the analyzer.



*Process samples may contain hazardous material in potentially flammable and/or toxic concentrations. Personnel should have a thorough knowledge and understanding of the physical properties of the sample and prescribed safety precautions before installing, operating or maintaining the analyzer.*

---

## To purge the analyzer for shipment or relocation

1. Refer to the procedure "**To isolate the analyzer for long-term shutdown (full-featured sample system)**" on page 4-10.
2. Disconnect the sample tubing at the inlet to the analyzer.
3. Connect clean, dry nitrogen to the sample inlet. Set to 30 PSIG.
4. Open any valves downstream from the analyzer to ensure nitrogen flow through both the sample cell and bypass.
5. Allow the analyzer to purge for 20 minutes.
6. Shut off the nitrogen purge and disconnect.
7. Close any shut-off valves downstream to isolate the analyzer from vent or low pressure flare.
8. Cap off all connections.

---

## To prepare the analyzer for shipment or storage

1. Follow all instructions "**To purge the analyzer for shipment or relocation**".
2. Cap all inlets, outlets, vents, conduit or gland openings (to prevent foreign material such as dust or water from entering the system)

using the original fittings supplied as part of the packaging from the factory.

3. Pack the equipment in the original packaging in which it was shipped. If the original packaging material is no longer available, the equipment should be adequately secured (to prevent excessive shock or vibration). Refer to **"Service"** on page B-22 for any questions related to packaging.
4. If returning the analyzer to the factory, complete the Decontamination Form provided by Endress+Hauser, refer to **"Service"** on page B-22. Attach to the outside of the shipping package as instructed before shipping.

## Storage

The packaged analyzer should be stored in a sheltered environment that is temperature controlled between -20° C (-4° F) and 50° C (122° F), and should not be exposed to direct sun, rain, snow, condensing humidity or corrosive environments.

## Disclaimers

Endress+Hauser accepts no responsibility for consequential damages arising from the use of this equipment. Liability is limited to replacement and/or repair of defective components.

This manual contains information protected by copyright. No part of this guide may be photocopied or reproduced in any form without prior written consent from Endress+Hauser.

## Warranty

For a period of 18 months from date of shipment or 12 months in operation, whichever comes first, Endress+Hauser warrants that all products sold by it shall be free from defects in material and workmanship under normal use and service when correctly installed and maintained. Endress+Hauser's sole liability and Customer's sole and exclusive remedy for a breach of warranty is limited to Endress+Hauser's repair or replacement (at Endress+Hauser's sole option) of the product or part thereof which is returned at Customer's expense to Endress+Hauser's plant. This warranty shall apply only if Customer notifies Endress+Hauser in writing of the defective product promptly after the discovery of the defect and within the warranty period. Products may only be returned by Customer when accompanied by a return authorization reference number (SRO) issued by Endress+Hauser. Freight expenses for products returned by Customer will be prepaid by Customer. Endress+Hauser shall pay for shipment back to Customer for products repaired under warranty. For products returned for repair that are not covered under warranty, Endress+Hauser's standard repair charges shall be applicable in addition to all shipping expenses.

# INDEX

---

## Numerics

4-20 mA current loop 3-7

### A

Absorption profile 1-6  
Acetone B-2  
Acetone-impenetrable gloves B-5, B-6  
Analyzer shutdown  
    Long-term 4-10  
    Short-term 4-9  
Attenuation 1-5

### B

Beer-Lambert absorption law 1-5

### C

Cautions 1-1  
Cleaning  
    Gas sampling lines B-1  
    Mirrors B-3  
Contamination B-1  
    Mirrors 1-7  
Control system  
    Heat trace 4-4  
    Tracer 4-4  
Current 1-6  
Current loop 3-7

### D

Detector 1-4

### E

Electrical noise B-2  
Electronics enclosure 3-5, 3-7  
Enclosure  
    Electronics 3-7, 3-8, 3-9, 3-10  
Erroneous readings 3-14  
Excessive sampling  
    Gas pressure B-19  
    Gas temperature B-19  
Excessive sampling gas temperature B-2

### F

Faults  
    **Null Fail Error** B-20  
    **P/T Fail Error** B-2, B-20  
    **Power Fail Error** B-1, B-3, B-19  
    **Spectrum Fail Error** B-20  
    Track Fail Error B-3  
Field pressure reducing regulator 4-1  
Field pressure reducing station 4-4, 4-5,  
    4-6, 4-9  
Flow meter 4-6, 4-9, 4-10, 4-11, 4-12  
    Sample 4-5  
    Sample Bypass 4-11

### G

Gas leaks 3-13, B-1, B-2  
Ground wire 3-5

### H

Hardware 3-2  
Heat traced  
    Temperature controller 4-4  
Heat traced power  
    SCS start-up 4-4

### I

Incident intensity 1-5  
Installation 3-2

### L

Laser beam 1-4  
Laser output fluctuations 1-6  
Leak detector 3-13, B-2  
Lens tissue B-5  
Lock-in amplifier 1-7

### M

Mating terminal block 3-8, 3-10  
Membrane separator B-1  
Mirror contamination 1-7, B-1, B-3

**N**

Natural frequencies 1-5

**O**

Optional analyzer hood 3-3  
Outline schematic A-5, A-6, A-7, A-8, A-9,  
A-11, A-12  
Output Signal  
4-20 mA current loop 3-7  
Serial output 3-7

**P**

Parameters  
Diagnostic  
PKDf B-3  
PKDI B-3  
Measurement and control  
**4-20 mA Alarm Action** B-21, B-  
22  
Peak tracking reset B-3  
Pin numbers 3-8  
Port  
Bypass return 3-14  
Pressure relief vent 3-14  
Sample inlet 3-13  
Sample return 3-13  
Pressure regulator 4-5, 4-6, 4-9

**R**

Raw data 1-6  
Recommendations and solutions to  
common problems B-1  
Resonances  
Natural frequencies  
Rotameter replacement B-15

**S**

Sample bypass 4-5, 4-10, 4-12  
Start-up 4-6  
Sample conditioning system (SCS) 4-1,  
4-4, B-7  
Periodic maintenance B-17  
Preventive and on-demand  
maintenance B-17  
Shut down 4-9  
Start-up 4-4  
Sample gas 1-4  
Sample probe 4-1, 4-4, 4-5, 4-6, 4-9  
Serial connection 3-7  
Service contact B-22, B-23

Signal wires 3-8  
Simplified sample system (SS500) 4-2  
Shutdown 4-9  
Isolate the analyzer 4-11  
Specifications A-2  
Start-Up 4-7  
Stainless steel tubing 3-11, 3-13, B-1  
System conditioning 3-14  
System models  
SS2000 1-8  
SS500 1-8

**T**

Temperature controller  
Electric tracer 4-4  
Tools 3-2  
Trace gas measurement (mixed  
background) 1-7  
Troubleshooting  
Cleaning mirrors B-3  
Tools and supplies B-5  
Contamination B-1  
Electrical noise B-2  
Excessive sampling gas pressure B-2  
Gas leaks B-1  
Tunable diode laser absorption  
spectroscopy (TDLAS) 1-4

**V**

Valve  
Control 4-6  
Flow meter control 4-6  
Isolation 4-1, 4-4, 4-5, 4-9  
Metering 4-6  
Relief 4-4, 4-9, 4-10  
Shut-off 4-5, 4-6, 4-9, 4-10, 4-11

**W**

Warnings  
General 1-1  
Wavelength Modulation Spectroscopy  
(WMS) signal detection 1-7



BA02182C/66/EN/01.21

[www.endress.com](http://www.endress.com)

---